

BRUNSWICK CEMETERIES BRUNSWICK, MAINE

CUMBERLAND COUNTY

**ADAMS CEMETERY
ANCIENT BURIAL GROUND
CHASE CEMETERY
FIRST PARISH CEMETERY & MEMORIAL GARDEN
GODDARD CEMETERY
HARTWELL / LITTLE CEMETERY
HEUSTON BURYING GROUND**

Donald & Mark Cheetham, 2004

**989.88741
.C515
m
2004**

Adams Cemetery

Adams Cemetery, also known as the Melcher or Hinkley Cemetery, is located on Adams Road, in Brunswick, Cumberland County, Maine. The cemetery is on the west side of Adams Road, adjacent to the road with a few large granite blocks bordering the roadside. It is composed of 15 marker stones with the earliest dated 1792. In back of the cemetery a steep banking leads down to a marsh.

Contents

- 1) Map illustrating the general arrangement of the cemetery and the placement of the individual marker stones.
- 2) Record of each individual stones inscription.
- 3) Index by family name giving the location in the cemetery.

Note

Numbering of the markers is only as an aid in locating the stone within the context of this survey and do not represent any town or cemetery association designation.

Type of marker, be it Slate, Marble, or Granite is indicated on the map for the cemetery.

This record of Adams Cemetery was produced by Donald Cheetham of Brunswick, Maine and Mark Cheetham of Richmond, Maine in 2004.

ADAMS CEMETERY, MAINE

W E S T

Embankment
down to marsh.



LEGEND

- S = Slate
- M = Marble
- G = Granite
-  Footstone





 Marker Stone: Double line indicates the side that is inscribed.

S
O
U
T
H

N
O
R
T
H



MPA LM  

Adams Adams Adams Adams





M  M  M  M 

Ring

G 

  LM



Melcher Melcher Melcher

S  S  S  M  M 

(Broken) Melcher



MES  HS



Smith Smith Smith



M  M  M 

AH

Hinkley Hinkley

S  S 

Rock Rock  

Rock Rock  

A D A M S
R O A D

E A S T

Harding
Road

Thomas Point
Road

ADAMS CEMETERY, Cumberland County, Brunswick, Maine

(1) **MARGARETTE PATTEN.**
wife of
FRANCIS ADAMS.
died Aug. 12, 1865.
aged 83 yrs.

Footstone: M.P.A.

(2) **FRANCIS ADAMS.**
born in Kingston Mass.
Dec. 14. 1769.
died in Brunswick
May 26. 1839.
Act. 69

Footstone: L.A.

(3) **CHARLOTTE,**
youngest dau. of
FRANCIS & MARGARETTE
ADAMS,
died Aug. 29, 1854,
Act. 27 yrs. 10 mos.

Footstone: F.A.

(4) **LOUISA.**
dau. of
FRANCIS & MARGARETTE,
ADAMS,
died Jan. 18, 1872,
aged 65 yrs.

Footstone: C.A.

(5) **CHARLES WARREN RING, Jr.**
Born Fall River, Mass. Apr. 2, 1936

(7)
.....
.....
..... 1832,
..... 86th year
of her age.
"Boast not thyself of to morrow."

Footstone: (broken)

(Marker stone broken)

(6) Sacred
to the memory of
Mr SAMUEL MELCHER,
who died
March 3, 1834:
in the 90th year
of his age
"The eye of him that hath seen me,
shall see me no more."

Note:

Footstones for stones 2, 3 & 4 appear to have been moved from their proper location.

- (8) In memory of
RELIANCE MELCHER
 dau of **SAMUEL & ISABEL**
MELCHER. died Nov. 29,
 1804. Aet. 36
 "A spirit now confined no more,
 I fly to realms above,
 To praise the being I adore,
 Andng the God I love.
- Footstone: 1804
- (Footstone and Marker stone
 broken)
- (11) In memory of
 Mrs. **MARY HINKLEY**
 wife of
AARON HINKLEY, Esq.
 who died March 27, 1807.
 Ae. 81
- (13) **MARY E.**
 wife of
 Dea. **JAMES SMITH**
 died Mar. 9. 1885
 Aet. 83 yrs.
- Footstone: M.E.S.
 (Marker stone broken)
- (15) **HENRY SMITH**
 died
 Dec. 24, 1851,
 Aet. 84 yrs. 4 mos.
- Here the christians work is done
 ended is the glorious strife;
 The conflict over, his course is run
 death is swallowed up of life.
- Footstone: H.S
- (9) **LOIS MELCHER**
 died
 June 2, 1860,
 Aet. 80 yrs.
 Loving and beloved in life and
 fondly remembered in death.
- Footstone: L.M.
- (10) **RACHEL MELCHER**
 died
 Sept. 30, 1863,
 Aet. 70 yrs. 7 mos.
- (12) In memory of
AARON HINKLEY, Esq.
 who died
 March 8, 1792;
 Ae. 76
- Footstone: A.H.
 Marker: U.S. Veteran
- (14) Dea.
JAMES M. SMITH
 died
 Sept. 8, 1879,
 Aged 81 yrs.
 Asleep in Jesus blessed sleep:
 From which none ever wake to weep.
- Footstone: J.M.S.

INDEX BY FAMILY

This index is arranged alphabetically by Family Name listing all Markers in the Cemetery. The numbers following the name indicate the location on the map and in the text where this name is represented.

Adams - 1, 2, 3, 4
Hinkley - 11, 12
Melcher - 6, 8, 9, 10
Patten - 1
Ring - 5
Smith - 13, 14, 15

**ANCIENT BURIAL GROUND
MAINE STREET
BRUNSWICK, MAINE**

CUMBERLAND COUNTY

Donald & Mark Cheetham 2004

Ancient Burial Ground

The Ancient Burial Ground was located off Maine Street, in Brunswick, Cumberland County, Maine. The cemetery it is thought was in the area now occupied by the underpass which leads to Mill Street west of Maine Street. Nothing remains of this cemetery, but a plaque commemorating it is located on a boulder near the main entrance of Fort Andross, formerly the Cabot Mill. The commemorative plaque was placed here by the 'Daughters of the American Revolution' local chapter in 1930. It reads:

To mark the site of
1688 Fort Andross 1694
and

1715 Fort George 1737

Also the earliest burial place, where are buried
BENJAMIN LARRABEE
Agent of the Pejepscot Proprietors and
Commander of Fort George, also **ROBERT** and
ANDREW DUNNING, killed by the Indians.

Erected by
Daughters of the American Revolution
1930

ANCIENT BURIAL GROUND - General Arrangement

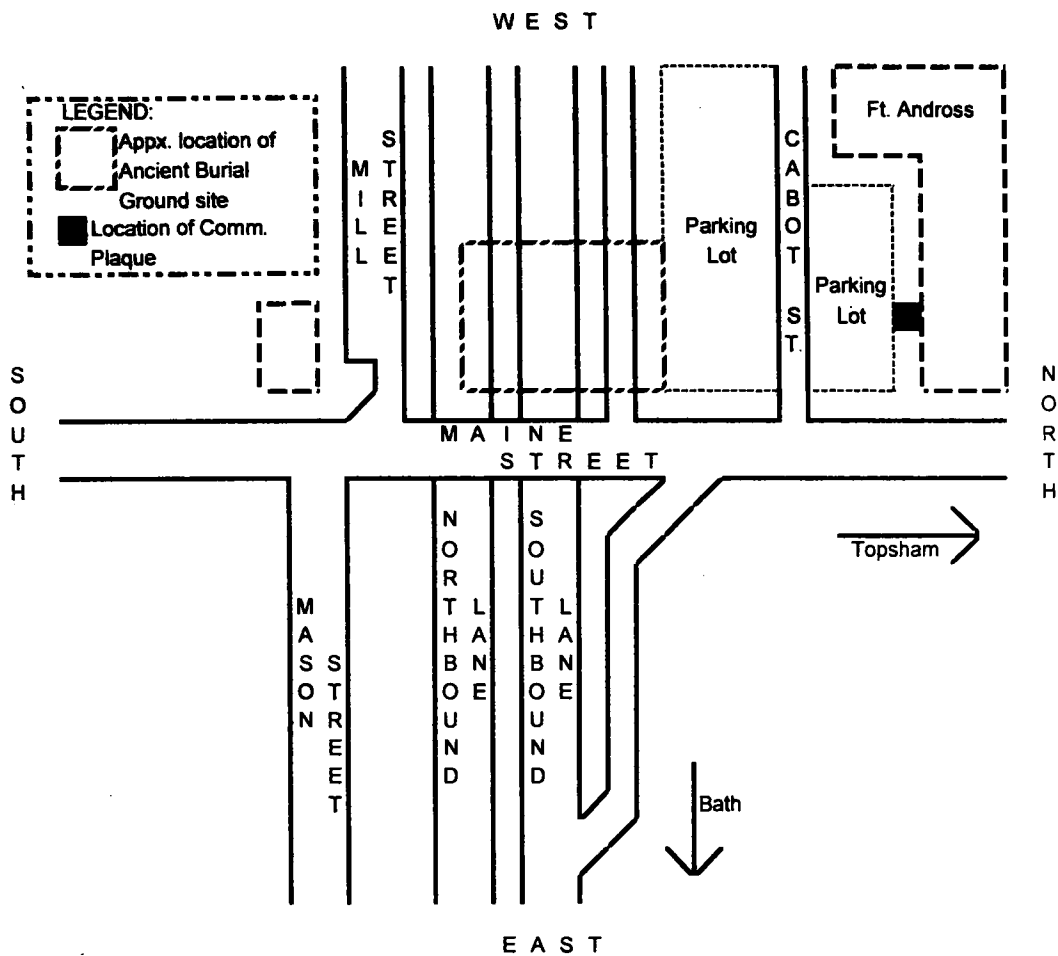

**CHASE CEMETERY
FLYING POINT ROAD
BRUNSWICK, MAINE**

CUMBERLAND COUNTY

Donald & Mark Cheetham 2004

Chase Cemetery

Chase Cemetery, also known as Bunganuc, Campbell or Jameson Cemetery, is located on the Flying Point Road, in Brunswick, Cumberland County, Maine. The cemetery is on private property on the south side of the Flying Point Road, set back in off the edge of a posted field about one mile west from Bunganuc Stream near the Freeport Town Line. The cemetery is composed of 11 stones with the earliest dated 1786 and is enclosed in a very rough stone wall at this time. When first visited in 1968 the cemetery was in far better condition, as it has deteriorated badly in the last 36 years. The map and records of the inscriptions from that date are here utilized with the 2 stones added since that time included; as most of the original stones are now broken and unreadable.

Contents

- 1) Map illustrating the general arrangement of the cemetery and the placement of the individual marker stones.**
- 2) Record of each individual stones inscription.**
- 3) Index by family name giving the location in the cemetery.**

Note

Numbering of the markers is only as an aid in locating the stone within the context of this survey and do not represent any town or cemetery association designation.

Type of marker, be it Slate or Marble is indicated on the map for the cemetery.

This record of Chase Cemetery was produced by Donald Cheetham of Brunswick, Maine and Mark Cheetham of Richmond, Maine in 2004.

CHASE CEMETERY - Brunswick, Maine

SOUTH

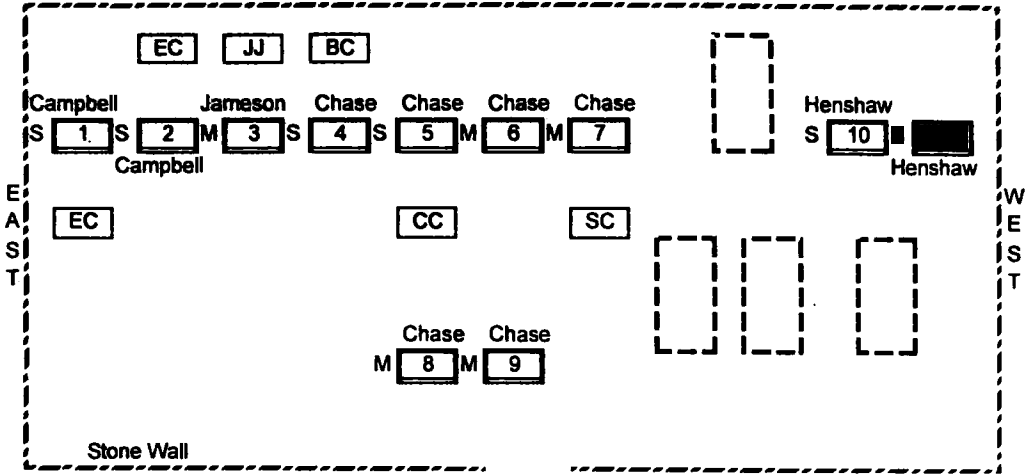

NORTH

LEGEND:



Marker Stone; double line indicates side inscribed



Footstone



Obvious depressions, probably unmarked graves.

S - Slate

M - Marble

**CHASE CEMETERY, Cumberland County,
Brunswick, Maine**

- (1) In memory of
Mrs ELIZABETH CAMPBELL
wife of
Mr DANIEL CAMPBELL
departed this life
Febry 16th 1786.
In the 84th Year
of her Age.
- Footstone:
Mrs ELIZh CAMPBELL
1786
- (2) **ELEANOR CAMPBELL**
wife of
JAMES JAMESON
Born in Saco
Aug. 28, 1739,
Died Jun 7, 1819
Footstone: E. C.
- (3) **JAMES JAMESON**
Born in Saco
May 24, 1738,
Died Sept. 24, 1818.
Footstone: J. J.
- (4) In memory of
Mr BENJAMIN CHASE;
departed this life
May 9th 1802
In the 65th Year
of his Age
Footstone:
Mr
BENJAMIN CHASE
1802
- (5) Sacred
to the memory of
Mrs CATHERINE CHASE
wife of **Mr BENJn CHASE**
who departed this life
Octr 9th 1815.
in the 73d Year of her Age
She lived a virtous and exemplay life
Her children call her blessed.
Footstone: C. C.
- (6) **ELIZABETH**
daughter of
BENJAMIN CHASE,
died Mar. 24, 1830,
Aet. 64.
- (7) **SUSANNA,**
daughter of
BENJAMIN CHASE
died Dec. 28, 1828
Footstone: S. C.
- (8) **MARY CHASE**
wife of
SAMUEL CHASE Esq.
died Feb. 23, 1830,
Aet. 48

(9) **SAMUEL CHASE Esq.**
died Mar. 24, 1830,
Act. 56.

(10) **JOHN HANDY HENSHAW**
loving husband of
ALICE ANITA STEVENS HENSHAW
born August 7, 1909
Norwood, N. J.
died March 9, 1998
Brunswick, Maine

"Yea, here, as the bridegroom rejoiceth
over the bride, so did God rejoice over
them..... for in this place they met with
abundance of what they had sought."

(11) **ALICE ANITA STEVENS HENSHAW**
beloved wife of
JOHN HANDY HENSHAW
born February 17, 1912
Greenwich, Conn.
died March 3, 1983
Brunswick, Maine
Her children arise up,
and call her blessed;
her husband also.

INDEX BY FAMILY

This index is arranged alphabetically by Family Name listing all Markers in the Cemetery.
The numbers following the name indicate the location on the map and in the text where this name is
represented.

Campbell - 1, 2
Chase - 4, 5, 6, 7, 8, 9
Henshaw - 10, 11
Jameson - 2, 3
Stevens - 10, 11

**FIRST PARISH CEMETERY
& MEMORIAL GARDEN
MAINE STREET
BRUNSWICK, MAINE**

CUMBERLAND COUNTY

Donald & Mark Cheetham 2004

First Parish Cemetery & Memorial Garden

First Parish Cemetery, also known as the Mere Point Cemetery, is located on Maine Street in Brunswick, Cumberland County, Maine. The cemetery is on Upper Maine Street near the intersection of Pleasant Hill Road and is composed of 180 marker stones and monuments with the earliest dated 1735. The Cemetery was originally the site of the first Meeting House of the First Parish Church established in 1717. The Meeting House was begun in 1719 but not completed until 1735, at which time the cemetery was founded. The Meeting House was lost to fire in 1834. The First Parish Memorial Garden was established in the back end of the cemetery in 2000 in which are placed the ashes of those more recently interred here and memorialized upon a large polished granite monument.

Contents

- 1) Map illustrating the general arrangement of the cemetery and showing the order of the detail maps.
- 2) Detail maps indicating the general placement of the individual marker stones and monuments.
- 3) Record of each individual stones inscription.
- 4) Index by family name giving the location in the cemetery.

Note

Numbering of the markers is only as an aid in locating the stone within the context of this survey and do not represent any town or cemetery association designation.

Type of marker, be it Slate, Marble, Granite or Metal is indicated on the map for the cemetery.

This record of the First Parish Cemetery was produced by Donald Cheetham of Brunswick, Maine and Mark Cheetham of Richmond, Maine in 2004.

FIRST PARISH CEMETERY - General Arrangement

SOUTH

FIRST
PARISH
CEMETERY

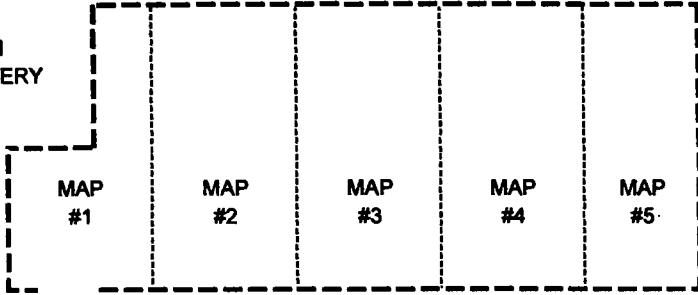

E
A
S
T

W
E
S
T

M A I N E
S T R E E T

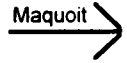

PLEASANT
HILL
ROAD

NORTH

FIRST PARISH CEMETERY - Range Layout

MAP #1

South

A	D	E	F	G	H	I	K	M	O	Q
B					J	L	N	P	R	
C										

Slate Fragments
& Footstones

- Z S Frag.
- ZZ S Frag.
- Slab
- Schist
- Slab
- Slab
- Slab
- Slab
- Rock
- Slab
- Slab
- Slab
- Schist
- S Frags.



Ross
S 119

Ross
S 120

Legend:

Marker Stones; Double line indicates the side inscribed. No double line indicates the stone is inscribed on top.

Footstone

- S - Slate
- M - Marble
- G - Granite

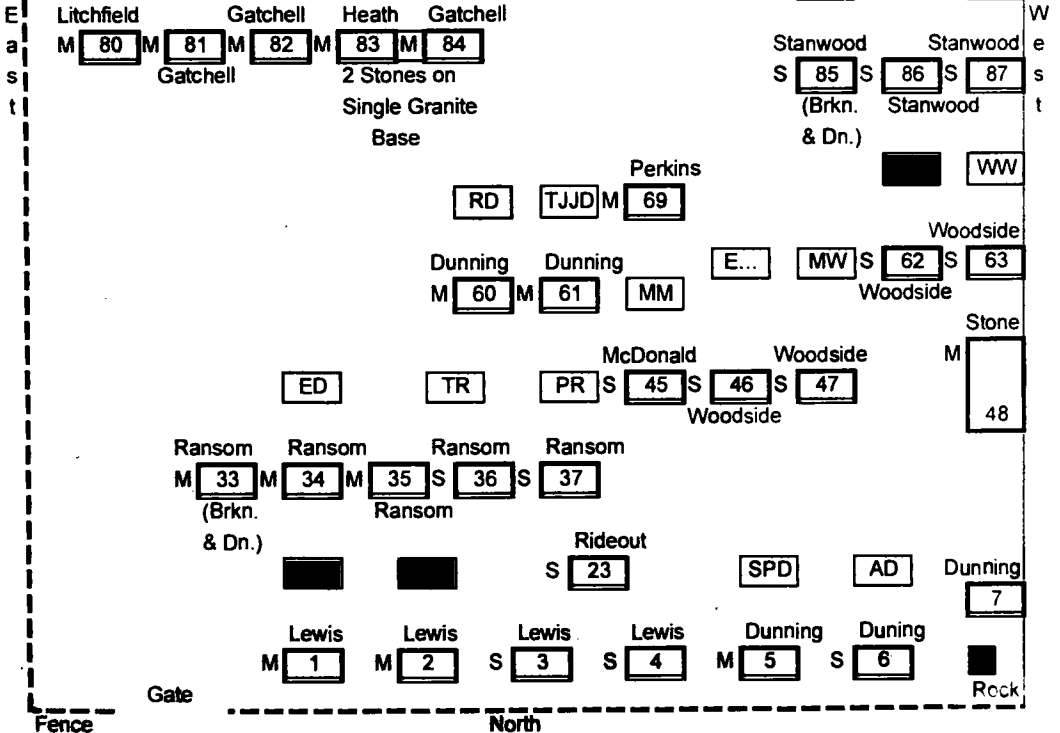

FIRST PARISH CEMETERY - Range Layout

MAP #2

South

S T U V W X Y

Slate Fragments
& Footstones

Durgin
M **162**

Ross
M **163**

LS

ES



Simpson
S **159**

Simpson
S **160**

Robinfon
S **161**

PS

ARG

RM

Starwood McFarland
S **105** S **106** S **107**
Starwood (Brkn.)

Standwood
S **108**

Starwood Starwood
S **88** S **89**
S



Martin Gyles Wilson Read
S **70** S **71** S **72** S
(Brkn.)

JS ES
S **74** S **75**
(Frag.)
Standwood

EW AS

Woodside Starwood
S **64** S **65**

Flagpole

Stone
M **49**

S **50**
Oulton

Cary
51

Simpson
Monument Boulder
38

Simpson
S **39** S **40**

S **24** Simpson
Ellet

Melcher Melcher Melcher
S **8** M **9** S **10**
EM

North

E
a
s
t

W
e
s
t

FIRST PARISH CEMETERY - Range Layout

MAP #3

South

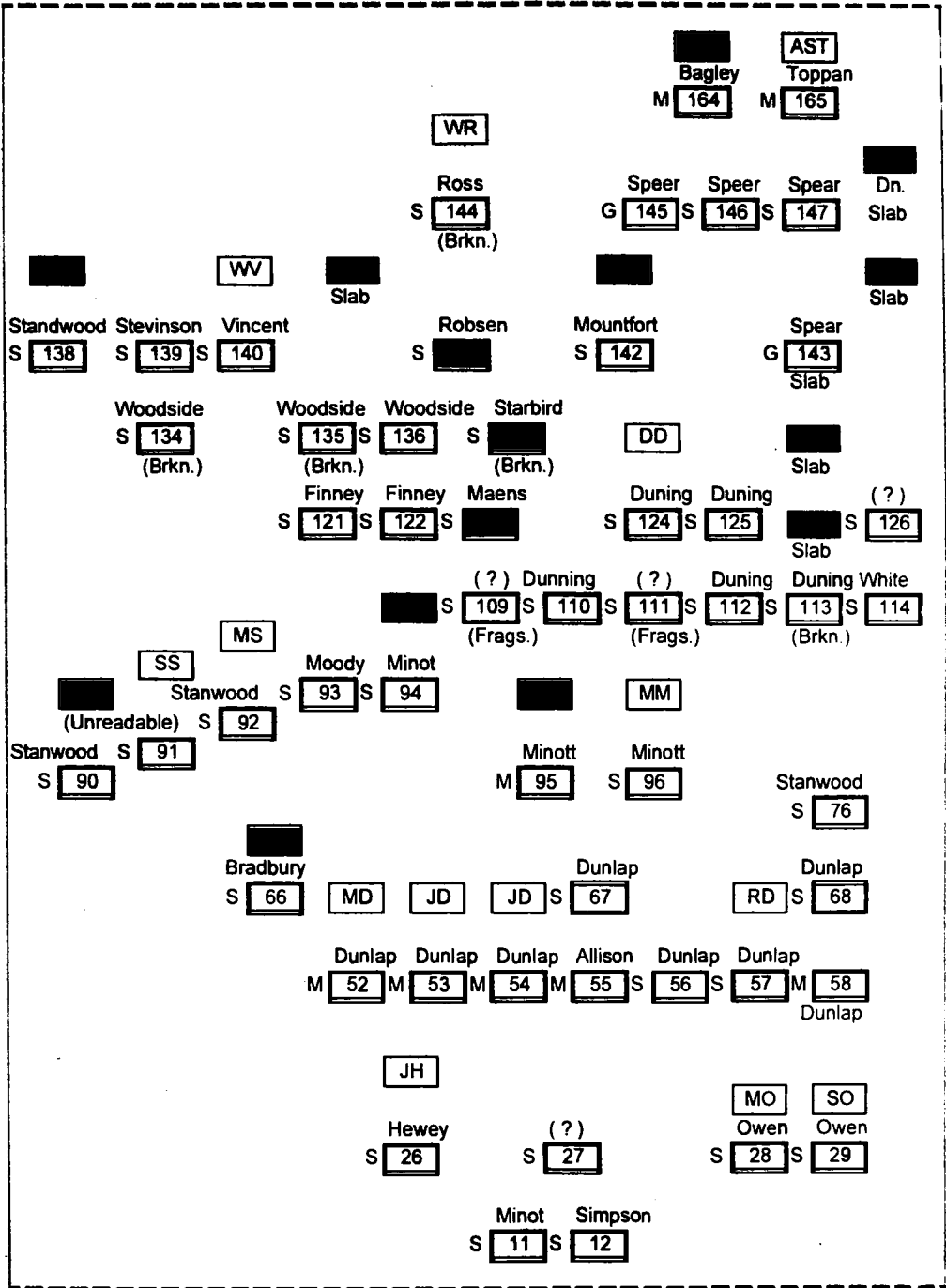

North

East

West

FIRST PARISH CEMETERY - Range Layout

MAP #4

South

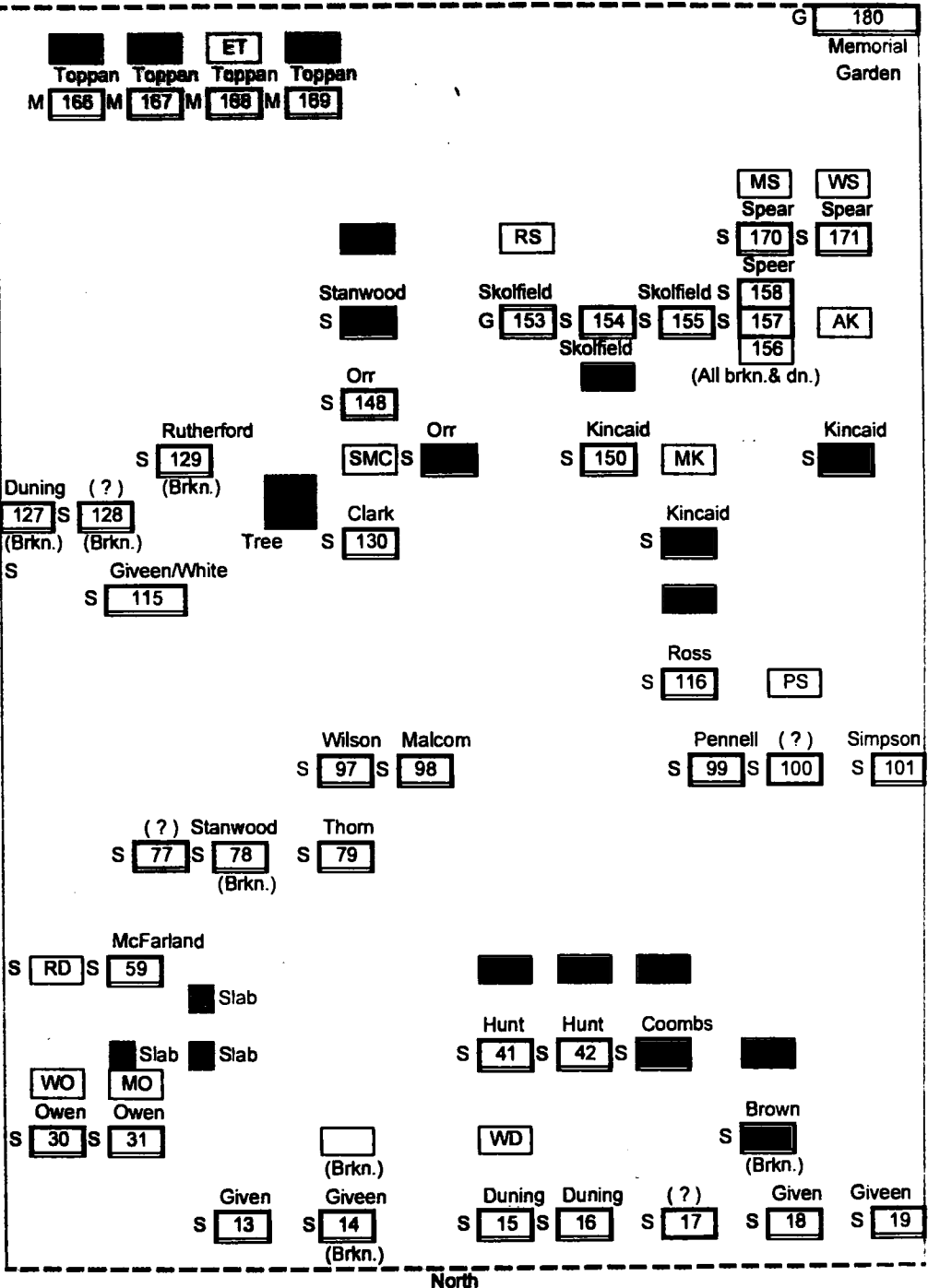

East

West

Toppan Toppan Toppan Toppan
 M 166 M 167 M 168 M 169

G 180
 Memorial Garden

MS WS
 Spear Spear
 S 170 S 171

RS
 Skolfield S 158
 G 153 S 154 S 155 S 157 AK
 Skolfield S 156
 (All brkn. & dn.)

Stanwood
 S
 Orr
 S 148

Rutherford
 S 129 (Brkn.)
 SMC S

Kincaid
 S 150 MK S

Duning (?)
 (Brkn.) S 127 S 128 (Brkn.)
 S
 Giveen/White
 S 115

Tree Clark
 S 130

Kincaid
 S

Ross
 S 116 PS

Wilson Malcom
 S 97 S 98

Pennell (?) Simpson
 S 99 S 100 S 101

(?) Stanwood Thom
 S 77 S 78 S 79
 (Brkn.)

McFarland
 S RD S 59
 Slab

Hunt Hunt Coombs
 S 41 S 42 S
 Slab Slab

WO MO
 Owen Owen
 S 30 S 31

(Brkn.)

WD

Brown
 S (Brkn.)

Given Given
 S 13 S 14
 (Brkn.)

Duning Duning (?) Given Given
 S 15 S 16 S 17 S 18 S 19

MAP 48 FIRST PARISH CEMETERY - Range Layout

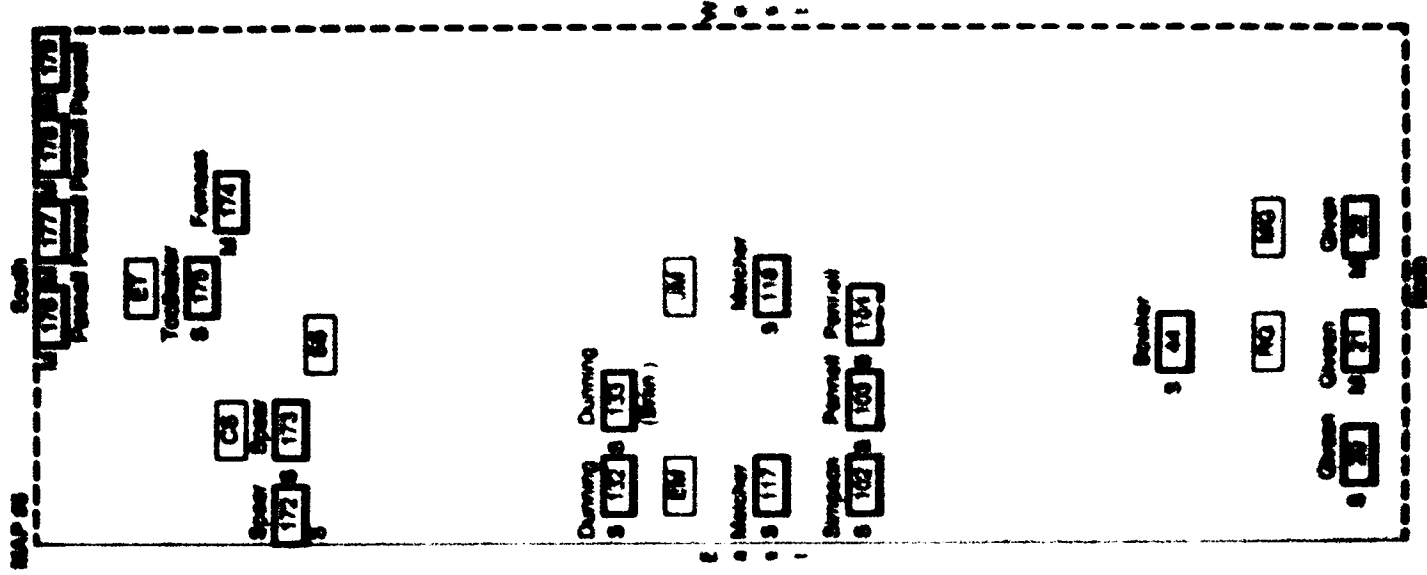

**FIRST PARISH CEMETERY, Cumberland County,
Brunswick, Maine**

(1)

HERBERT
son of
**ROBERT G. &
HARRIET M. LEWIS.**
died Nov. 25, 1852.
Aet. 9 months.
Its little spirit's gone to rest.
And Jesus' arms is blessed:
It's joined the concord in the sky,
with happy infants when they die.

Footstone: H. L.

(2)

CAROL H.
son of
**ROBERT G. & HARRIET M.
LEWIS.**
died July 4, 1863.
Aet. 4 yrs. 5 mos.
21 ds.
Thou who hast ta'en for'er away
our blest, our darling one;
Give strength to raise our hearts to say
O God ! Thy will be done.

Footstone: C. H. L.

(3)

Mr.
JAAZANIAH LEWIS
died
Sept. 18, 1841,
Aet. 52.
-
My friend to Heaven is gone;
His track I see and I'll pursue
the narrow way till him I view.

(4)

HARRIET B.
wife of
JAZANIAH LEWIS
died May 8, 1865
Aet. 72 yrs.
Ah ! Tis in heaven where Christ is gone
our mother with angels dwells.
There we may hope to meet again
that mother we loved so well.

(5)

SUSAN P.
dau. of
**ANDREW & MARGARET
DUNNING.**

Footstone: S. P. D.

(6)

In memory of
Mr ANDREW DUNING
who died
May 23, 1804 aged
59 years

Footstone: A. D.

(7) **EBENEZER**, son of
**ROBERT & SALLY
DUNNING,**
died Feb. 13, 1816
aged 16 days.

(8) Mrs. PEGGY MELCHER
wife of
Mr. JOSIAH MELCHER
who died May 13
1800
Aetat 23 years
Blessed are the dead who die in ye
Lord

(9) In memory of
ELIZABETH.
wife of
SAMUEL MELCHER 2nd
who died
Feb. 1804
Aet. 27.
Asleep in Jesus, blessed sleep.

Footstone: E. M.
(Leaned against Marker Stone.)

(10) Mrs.
PEGGY
MELCHER
(Footstone for Stone 8;
in wrong location.)

(11) In memory of
MARY MINOT,
died Mar. 4, 1823.
Aet. 48.

(13) In memory of
Mr. JOHN GIVEN
who died May 28th
1795
in the 77th year
of his age

(12) In memory of
Mrs ELIZABETH the wife
of Mr JOHN SIMPSON
who died June 20,
1790
in the 90th year
of her age.

(Epitaph unreadable, stone
badly weatherd.)

(14) In memory of
Mrs. SARAH GIVEEN,
widow of
Mr. JOHN GIVEEN,
Obt Apr 7, 1809
Aet. 86.

Footstone: (Broken)

(15) In
memory of
WILLIAM DUNING
son to Mr WILLIAM
& Mrs JEAN DUNING
died March 31, 179...
in the 23rd year
of his age.

Footstone: W. D.

(16) In
memory of
ELIZABETH DUNING
daur to Mr WILLIAM
& Mrs JEAN DUNING
died April 30, 1798
in the 15 year
of her age.

(17) (Stone blank.)

(18) In memory of
Mr. SAMUEL GIVEN.
who died
Dec. 17, 1830.
Act. 69.

(19) In memory of
Mrs. BETSEY,
wife of Mr.
SAMUEL GIVEEN,
died
Sept. 26, 1821:
Act. 49.

(20) In memory of
Miss SARAH GIVEEN,
daughter of
Mr JOHN & Mrs
SARAH GIVEEN,
Obt March 23,
1808:
Act. 53.

this
How blest the change, to leave a world like
for robes of glory and a crown of bliss.

(22) In memory of
Mrs. MARY GIVEN
who died
June 29, 1826.
Act. 78.

(21) In
memory of
Capt. ROBERT GIVEEN
who died
Sept. 26, 1810:
Act. 61

"Farewell my friends, dry up your tears
I must lie here till Christ appears."

Footstone: M. G.

Footstone: R. G.
1810
Marker: S.A.R. 1775

(23) MARY ANN
daughter of
JACOB & SUSAN D.
RIDEOUT, died
Feb. 14, 1844,
Act. 11 yrs.

(24) In memory of
Mrs RUTH ELLET
wife of
Mr JAMES ELLET
died May 4th
1786
aged 37 years.

Farewell dear child till that bright morn,
when Gabriel's trump shall sound,
to change the saints that living be
and raise those under ground.

Footstone:
RUTH ELLET
1786

(25) In memory of
Mr JAMES ELLET
died Jan^y 27th
1783
In the 67 year
of his age

(26)

Here lies buried
the body of
Mr JAMES HEWEY
who departed this life
Febry 20th 1779
in the 79th year
of his age.

Footstone:

Mr
JAMES HEWEY
1779

(27) (Stone badly weathered, unreadable.)

(28)

In memory of
Miss MARY OWEN
dau. of
Mr Wm & Mrs MARY
OWEN
who died Oct. 22,
1789
Aet. 25.

Footstone:

M. OWEN
1789

(29)

In memory of
Mr SAMUEL
OWEN son to
Mr Wm & Mrs MARY
OWEN
who died
Dec. 27
1792.
Aet. 21

Footstone:

S. OWEN
1792

(30)

In memory of
Mr WILLIAM
OWEN
who died
July 3
1799
Aet. 61

Footstone:

W. OWEN
1799

(31)

In memory of
Mrs. MARY OWEN
wife of
Mr. WILLIAM OWEN.
who departed this life
June 22, 1818
Aet. 78 years

Hail, glorious gospel ! Heavenly light whereby
we live with comfort and with comfort die.

Footstone: M. O.

(32)

In memory of
Mr EZEKIEL BROWN.
who died
June 4, 1798.
Aet. 43.

Footstone:

E. B.
1798

(33)

MARGARET ANN
dau. of
DAVID & MARGARET
RANSOM
died Feb. 23, 1859
Aet. 16 yrs. 6 mos.

O weep not ye where child hath soared
in seraph to the world above
where endless day around her poured
and happy spirits dwell in love.

(34)

MARGARET S.
wife of
DAVID RANSOM.
died
July 26, 1883
Aged 74 yrs. 8 mos.

I am the resurrection and the life
He that believeth in me though he were
dead yet shall he liveth.

Footstone: E. D.
(Footstone in wrong location.)

(35)

DAVID RANSOM.
died
Feb. 8, 1866.
aged 71 yrs.
5 mos.

He is gone to the grave but we will not deplore this
though sorrows and darkness encompass the tomb
thy savior hath passed through the portals below the
..... his love is thy guide through the

(36)

Sacred
to the memory of
THOMAS RANSOM
who died Aug. 8, 1821:
Aet. 57.

Sweetly he lay his dying head;
upon his makers breast;
His maker call'd his soul a way
and laid his flesh to rest.

Footstone: T. R.

(37)

Mrs.
PRUDENCE,
wife of
THOMAS RANSOM,
died
Dec. 22, 1843,
Aet. 72

Ah ! thou art gone my mother dear,
in death's cold chambers now to dwell;
Soon to the dead the Lord will say,
arise come forth - immortal be;
and dwell with me eternally.

Footstone: P. R.

(38) Simpson Monument

(Bronze Plaque on large Granite Boulder on dressed Granite base.)

This boulder
taken from their old homestead
is erected in memory of
WILLIAM SIMPSON
1691 1771
AGNES LEWIS SIMPSON
1700 1778
who came from Scotland
and settled at
Simpson's Point, Brunswick, Me.
about 1735

Marker Stones:

(39) Here lies buried
the body of
Mr WILLIAM SIMPSON
died May 4th
1771.
aged 86 years.

(40) In memory of
AGNES SIMPSON
wife of
WILLIAM SIMPSON
departed this life
Decr 27th 1778.
aged 78 years.

(41)

In memory of
Mr JOHN HUNT, he
died December the
19th 1789 in the
73 year of his age.

The sweet remembrance of the just
shall flourish when he sleeps in duft.

Footstone:

Mr JOHN
HUNT
1789

Marker: S.A.R. 1775

(42)

In memory of
Mrs MARY HUNT
wife of
Mr JOHN HUNT
died Dec 23^d 1797
in the 74th year
of her age

Footstone:

MARY HUNT
1797

(43)

In memory of
MARY COOMBS,
widow of ISAAC COOMBS,
died March 14, 1815:
Act. 45.

Footstone: M. C.

(44)

In memory of
JANE BOWKER,
wife of
WASHINGTON BOWKER,
who died Dec. 4, 1811:
Act. 26

- (45) In memory of
Mr. MAJOR Mc.DONALD.
who died
May 15, 1831.
aged 43 years & 8 mo.

Footstone: M. Mc.D.
- (46) In memory of
Miss ELIZABETH WOODSIDE
died Jan. 15, 1826.
Act. 68.

Footstone: E.....
(Broken.)
- (47) In memory of
Mrs. MARY, widow of
Mr. VINCENT WOODSIDE,
died Oct. 12, 1826.
Act. 99.

Footstone: M. W.
- (48) BENJAMIN STONE
1726 - 1800
his wife
REBECCA LITTLEFIELD
1733 - 1802
- (49) WILLIAM STONE
May 7, 1761,
Apr. 5, 1785.
JOHN STONE
July 21, 1768,
July 7, 1787.
MATTHIAS STONE
Dec. 20, 1773,
Nov. 12, 1792.
- (50) Here lyes buried the
body of Mrs MARY OULTON
the daughter of
JOHN OULTON Esqr
who Decd 27th of Dec.
1748 in the 33^d year
of her age
- (51) JAMES CARY,
departed this life
Augt 9, 1816,
Act. 65.
also JONa CARY,
son of
JAMES & SARAH CARY,
died June 16, 1819,
Act. 31.
- (52) Sacred
to the memory
of
Mrs. MARY,
relict of
JOHN DUNLAP Esq.
who died
Sept. 21, 1838.
aged 83 years.

Footstone: M. D.

(53)

Sacred
to the memory
of
Mrs. JENNET DUNLAP,
wife of
JOHN DUNLAP Esq.
who departed this life
March 11, 1786.
Aet. 36 years.

"The memory of the just is blessed"

Footstone:

Mrs. JENNET DUNLAP
1786

(56)

Sacred to the memory of
ROBERT, son of
JOHN & MARY DUNLAP,
who departed this life Mar^h 22, 1792
aged 1 year & 6 mo
This mournful monument was
erected by his forrowful parents.

Like flowry fields our children ftan^
pleaf'd with the morning light,
the flowers beneath ye mowers band,
lie withering E'er tis night.

(58)

Sacred
to the memory of
Rev. ROBERT DUNLAP,
First settled minister of Brunswick,
born in Ireland, Aug. 1715;
educated at Edinburgh;
came to America, June 1736;
settled in Brunswick, 1747;
died June 26, 1775,
Aet. 60.

"Behold a sower went forth to sow"

(54)

Sacred
to the memory
of
JOHN DUNLAP Esq.
who departed this life
July 30, 1824,
Aet. 86 years.

Footstone:

JOHN DUNLAP Esq.
1824.

(55)

Sacred
to the memory of
JANE ALLISON,
widow of
Rev. ROBERT DUNLAP,
died Mar. 31, 1797,
Ae. 86.

(57)

In memory of
ROBERT DUNLAP
son of Mr JOHN &
Mrs. JENNET DUNLAP
died May 8th 1784
aged 9 years & 6 mo

Footstone:

ROBERT DUNLAP
1784

A footstone located next to this stone is
marked:

ROBERT DUNLAP
1792

This stone corresponds to stone 56
but may have been placed at some
time in the wrong location.

(59) Here lyes ye body of
ANDREW McFARLAND
died Octr ye 24
1742 in ye 18
year of his age

(61) In memory of
Capt. THOMAS J. J. DUNNING,
who died
May 22, 1835
aged 50 years
My loving friends as you pass by,
on my cold grave pray cast an eye,
as I am now so you must be,
prepare to die and follow me.
A. Cary Feeit, Boston

Footstone: T. J. J. D.

(63) In memory of
WILLIAM WOODSIDE
who died April 14th
1801
aged 66 years.

Footstone:

Mr.
WILLIAM
WOODSIDE

(65) In memory of
ANN STANWOOD
died Jan. 8, 1831:
aged 75 years.

Footstone:

A. S.
1831

(60) REBECCA.
wife of
T. J. J. DUNNING.
died Apr. 12. 1881.
aged 85 yrs. 8 m's.
Blessed are the peace makers for they
shall be called the children of God.

Footstone: R. D.

(62) In memory of
Mr
VINCENT WOODSIDE
died Sept 13th
1802
in the 76th year
of his age

Footstone:

VINCENT WOODSIDE

(64) In memory of
Mrs. ELIZABETH WOODSIDE
wife of
Mr. WILLIAM WOODSIDE
who died Octr 5, 1798
in the 63 year
of her age.

Footstone:

Mrs.
ELIZABETH
WOODSIDE

(66)

Here lie interr'd,
the remains of
Mrs MARY BRADBURY.
relict of
Mr WYMAN BRADBURY:
After a long,
virtuous and pious life,
she died Jan. 8, 1797:
aged 93 years.

Her children call her blessed: & erect
this stone to her memory.

Footstone:
M. B.
1797

(69)

LUCY ELLEN,
daughter of
CHAS. H. & MARTHA L.
PERKINS, died
Sept. 22, 1845,
Aet. 5 mos. 20 ds.

So the lovely blooming flower
fades and withers in an hour
so our transient comforts fly
pleasure only blooms to die.

(72)

Here lies ye body of
HANNAH WILSON
Daup of Mr SAMUEL &
Mrs MARY WILSON
died Novr ye 26th
1763. Aged 13 months

Footstone: H. W.

(74) (Marker stone reduced to fragments)

Footstone:
Mrs JEANNOT
STANWOOD

(67)

In memory of
Mrs JENNET DUNLAP
wife of
Mr JOHN DUNLAP
died March 11, 1786
aged 36 years

(68)

Here lies buried the
body of the Rev.
ROBERT DUNLAP who
departed this life
June 26th 1775 in the
60th year of his age

(70)

Here lies the body of
LETTICE MARTIN wife
of Mr JOHN MARTIN Junr
who died December
the 23d 1761 in the 24th
year of her age.

(71)

Docr SAMUEL GYLES
aged 32 years
Decd Febry ye 11th
1758

(73)

Here lyes buried
the body of
Mrs HANNAH READ.
wife to Mr JOHN
READ. died March
ye 8th 1746/7 in ye 22d
year of her age

Footstone: (Blank)

(75) Here lies buried
the body of Lieut
EBENEZER STANDWOOD
who departed this life
July 21st 1772
aged 77 years.

Footstone:

Lieut EBENEZER
STANDWOOD
1772

(76) In memory of
EBENEZER STANWOOD Junr
son of EBENEZER
& MARTHA STANWOOD
died Sepr 13th 1792
in the 24th year
of his age.

(77) (Stone badly weathered and unreadable.)

(78) In memory of
Mrs MARTHA
STANWOOD
wife of
Mr EBEN. STANWOOD
who died Oct. 12th
1802: Aet. 57.

(79) Here lies buried
the body of Mr
THOMAS THORN
who died June
the 14th 1759
aged 23 years.

(80) FRANCES A. LITCHFIELD
1839. - 1905.

(81) DENNIS O. GATCHELL
1853. - 1898.
Lost on Steamer Portland,
off Boston. Nov. 27, 1898.

(82) JOHN S. GATCHELL,
1840 - 1863.
U.S. Navy 1861 to 1862.
Co. F. 24th Me. Regt.
U.S. Vols. 1862 to 1863.

(83) HANNAH HEATH
wife of
DENNIS GATCHELL.
1814. - 1886.

Marker: U.S. Veteran

(84) DENNIS GATCHELL,
1812 - 1899
Co. B. 15th Me. Regt.
U.S. Vols. 1861 to 1865

Marker: Post 22 G.A.R.

(85)

In memory of
Mr NATHANIEL STANWOOD
who died
Feb. 3, 1818:
aged 26 years
& 8 months

The once lov'd form now old & dead,
each mournful tho't employs
and nature weeps her comforts fled
and withered all her joy.

Footstone:

N. S.
1818

(87)

In
memory of
Mr SAMUEL STANWOOD,
who died
April 27, 1807
Act. 48.

Softly his dying head he lay
upon his makers breast;
His maker call'd his soul away
and laid his flesh to rest.

Footstone: 1807

(90)

Here lies buried the body
of Mrs JANET STANWOOD.
wife of Dean SAMUEL
STANWOOD who died Feby
22d 1776 in the 55th year
of her age.

Footstone: Mrs
J. S.

(86)

Mrs. ELISABETH,
wife of
SAML. STANWOOD,
died
Sept. 3, 1825,
Act. 63.

-
Jesus can make a dying bed
feel soft as downy pillows are,
while on his breast I lean my head,
and breathe my life out sweetly there.

(88)

In memory of
Capt. WILLIAM STANWOOD
who departed this life
July 17, 1797 in the
71st yr. of his age

Marker: S.A.R. 1775

(89)

In memory of
ELIZABETH STANWOOD
widow of
WILLIAM STANWOOD
died Oct. 6, 1819
in the 93rd year
of her age.

(91) (Marker Stone Unreadable)

Footstone: Deacon SAMUEL
STANWOOD
1790

(92)

In memory of
Mrs. MARY STANWOOD
widow of
Deac. SAM^l STANWOOD
died Sept. 1812 Act. 74

Footstone: M. S.
1812

(93) Here lies buried the body of
SAMUEL MOODY Esqr
one of his Majesty's Justs of ye
Peace for the County of York.
& Commander of his Majesty's Fort
George at Brunswick, who deceas'd
Sept^r 22^d 1758
in the 58th year of his age.

(95) In
memory of
HENRY MINOTT,
who died
June 11, 1830,
Act. 52

"Hope looks beyond the bounds of time
when what we now deplore,
shall flourish in immortal prime,
and bloom to fade no more."

Footstone: H. M.

(96) Mrs. MARGARET
MINOTT
wife of Mr. STEPHEN
MINOTT who died
Dec. 12th 1802
in the 56 year of her age

Footstone: M. M.
1802

(97) Here lies buried
the body of Mr
JAMES WILSON
who departed this life
September ye 9th 1743
in the 73^d year
of his age

(94) Here lies the body of
JOHN MINOT Esqr
late Chief Justice of the Court of
Common Pleas in the County (of York)
died Jan^y 10th 1764 in the (70th year)
of his age having been (employed)
in many publick stations (he discharged)
them with great honor (and credit)
bleffed are the dead who die in the (Lord)
the memory of the just is bleffed.

Footstone: JOHN MINOT Esq.
1764

(Marker Stone broken)

(In front of this marker stone laying flat
on the ground is a partial stone which reads:)

(In mem)ory of
(HAN)NAH MINOTT
(w)idow of
(JOHN) MINOTT Esqr
(who died 14th) Augst 1788
(in the 91st year of her age.)

(Note: Items in parenthesis above are
determined from previous records as
the stones are now damaged and
missing this information.)

(98) Here lyes buried
the body of
Mr WILLIAM MALCOM
who departed this life
April ye 12th 1753 in ye
46th year of his age.

(99) In memory of
MARY
daughter of ROBERT &
JANE PENNELL.
who died
April 22, 1833
aged 12 years 10 mo.

(100) (Unreadable)
Footstone: P. S.

(101) PEGGY
daur of Mr THOMAS
& Mrs PEGGY SIMPSON
born March 21, 1813
died Feb. 4, 1814.

(103) ALICE,
wife of
THOMAS PENNELL,
died Dec. 25, 1839,
Ae. 91.
Blessed are the dead that die in the Lord.

(105) In memory of
Mr PHILIP STANWOOD
who died Dec. 28th
1799
in the 39th year
of his age

Footstone:
PHILIP STANWOOD

(102) In memory of
Mrs PEGGY SIMPSON,
wife of
Mr THOMAS SIMPSON,
who died Apl 22, 1813;
Aet. 22.
"Be thou faithful unto death & I
will give thee a crown of life."

(104) In memory of
THOMAS PENNELL
who died
Nov. 25, 1812;
Aet. 74.
My loving friends as you pass by
on my cold grave may cast an eye
remember as I am so you must be
prepare to die & follow me.

(106) AGNES R.
relict of
PHILIP STANWOOD
and widow of
DAVID GREEN,
died Mar. 4, 1844,
Aet. 77

Footstone: A. R. G.

(107) Here lies the body of
Mr ROBERT McFARLAND
died Octr 31st 1773
aged 30 years
9 months
also
DAVID McFARLAND
son of
Mr ROBERT McFARLAND
died Octr 3d 1773
aged 19 months

Footstone: Mr ROBERT
McFARLAND
1773

(108) Here lyes the : Here lyes ye body : EBENEZER
 body of Mr : of Mr DAVID : STANDWOOD
 THO^s STANDWOOD : STANDWOOD who : who died
 who died June : died June ye 13th : Augst ye 5th
 13th 1752 : 1752 in ye 31st : 1735 in
 in ye 22^d year : year of his age : ye 3^d year
 of his age : : of his age
 The sons of Lieut. EBENEZER STANDWOOD

(109) (Unreadable)

(111) s.....
 bright, but hold him in
 and emulate his virtues.

(110) In memory of
 Mrs ELIZABETH
 DUNNING widow of
 ANDREW DUNNING Esq.
 who died March 4, 1801
 Aet. 61.

(Only fragment remains.)

(112) In memory of
 DAVID DUNING
 son of Mr ANDREW &
 Mrs ELIZABETH DUNING
 died 26th Sepr 1771
 in the 3^d year
 of his age

(113) In memo(ry of)
 MARY DU(NING)
 daur of ANDw & ELIZ(ABETH DUNING)
 who departed (this life)
 Febr 25th (1798)
 in the 25th y(ear of her age)

(114) Here
 lies intern'd ye
 body of Mr DAVID
 WHITE who died June 7th
 1774 aged 28 years.

(Note: Items in parenthesis above are determined from previous records as the stone is now damaged and missing this information.)

(115) Here lies ye body of : Here lies ye body of : Here lies the body of
 Mr HUGH WHITE : Deacon DAVID GIVEEN : Mrs MARY GIVEEN
 who died the 17th : who died the 16th : wife of Deacon
 day of October : day of June : DAVID GIVEEN
 1750 : 1763 : who died Febr
 aged 35 years : aged 78 years : ye 3rd 1741
 : : aged 66 years

(116) In memory of
JENNET ROSS
wife of
WILLIAM ROSS
died April 7th 1792
in the 39th year
of her age

Footstone:
JENNET ROSS
1792

(117) Memento Mori
Mrs ELIZABETH
A. MELCHER,
wife of Mr AARON
MELCHER, died Nov. 15
1802 : Aet. 28.

The grave receives th' inconectious duft
the spirit lives among the juft
where youth & virtue o'er the tomb
shall triumph in immortal bloom.

Footstone:
ELIZABETH
MELCHER
1802

(118) In
memory of
Mrs JANE MELCHER
wife of
Mr AARON MELCHER
who died
Jan. 28, 1806
Aet. 30.

Few years she pass'd & then resign'd her breath
in life belov'd, lamented much in death.
Hence reader, learn how few the hours we have
improve them well & live beyond the grave.

Footstone: J. M.
1806.

(119) MARY,
wife of
JAMES ROSS,
died April 27:
1818:
Aet. 67.

Footstone: M. R.

(120) JAMES ROSS,
died May 22,
1817:
Aet. 68.

Footstone: J. R.
Marker: S.A.R. 1775

(121) In memory of
Mrs ALICE FINNEY
wife of
Mr ROBERT FINNEY
died Feby 7th 1784
in the 84th year
of her age

(122) Here lies the body of
Mr ROBERT FINNEY
aged 53 years
died Novr 28th
1751

(123) Here lies the body of
Mr THOMAS MAENS who
died May 10th 1756
aged 33 years.
ROBERT MAENS who died
May 10th aged 16 months

(Stone broken.)

(124) In memory of
Capt DAVID DUNING
who departed this life
Augst 16th 1793
in the 88th year
of his age

Footstone:
DAVID DUNING

(126) (Unreadable)

(128) Mr HUGH.....
WHITE

(Only fragment of stone remains.)

(129) Here lies ye body of
JOHN RUTHERFORD
son of ye Revd Mr
ROBERT & Mrs ELIZth
RUTHERFORD who died
Janry 22 1741/2 in ye
25th year of his age.

(131) MARY KINCAID
wife of
PATRICK KINCAID
died Dec. 20, 1821
aged 74.

Footstone: M. K.

(125) In memory of
Mrs MARY DUNING
consort of
Capt DAVID DUNING
died Augst 16th 1784
aged 74 years.

(127) Here (lies buried)
the (body of)
Lieut JA(MES DUNING)
who died (June 8th)
1752 (in the 61st)
year of h(er) age)

(Note: Items in parenthesis above are
determined from previous records as
the stone is now damaged and missing
this information.)

(130) In memory of
SAMUEL CLARK : MARTHA CLARK
died Febry 28th : wife of
1784 : SAMUEL CLARK
aged 86 years. : died May 28th 1791
aged 84 years.

Footstone: SAMUEL
& MARTHA CLARK

(132) In memory of
Miss REBECCA DUNNING
daughter of Mr ANDREW &
Mrs ELIZABETH DUNNING
who died
April 11th 1806
Act. 20.

(133) (In memory) of
(Miss JANE DUNNING,
(dau~~r~~) of
(ANDREW) & ELIZABETH
DUNNING
who died July 10,
1814
Act. 43.
Nor pain, nor grief, nor anxious care
invade thy bounds.

(Note: Items in parenthesis above are
determined from the remaining fragment
located at the rear of the cemetery, see (Z).)

(134) Here lies ye body of
Mr JAMES WOODSIDE
son of Capt WILLIAM
& Mrs ANN WOODSIDE
died Janry ye 30th
1741/2 in ye 15th
year of his age.

(135) Here lyes buried
the body of
ANNA WOODSIDE
wife of Capt WILLIAM
WOODSIDE aged 42
years died Dec. ye 1st
1745

(136) Here lies buried
the body of
WILLm WOODSIDE Esq.
who departed this life
Janry 21st 1778
aged 75 years.

(137) Here lyes buried
the body of
Mr JOHN STARBIRD
died June 30, 1753
in the 52nd year
of his age

(138) Here lies buried
the body of
THOMAS STANDWOOD
son of Wm STANDWOOD
who departed this life
Novr 11th 1774
in the 22d year
of his age

(139) Here lyes buried
the body of Mrs
MARGRET STEVINSON
wife to Mr WILLIAM
STEVINSON aged 65
years. Decd Aug
ye 15th 1757

Footstone: THOMAS
STANDWOOD

(140) Here lies interned the body of
WILLIAM VINCENT
who departed this life
November 27th 1760
in the 54th year
of his age.

Footstone:
Mr. WILLIAM
VINCENT

(141) In memory of
Mrs ANNE ROBSEN
who departed
this life
April 26th 1784
in the 39th
year of
her age

- (142) In memory of
JOHN, (son of Mr.
EDMUND & Mrs.
SARAH MOUNTFORT)
 who died Jan. 9th
 aged 1 mo & 19 days.
 1795
 O death where is thy sting
 O grave where is thy victory !
 Footstone: J. M.
- (143) Here lies buried
 the body of **ELIZABETH**
SPEAR who died
 Nov. ye 9 1742
 aged 27 years.
- (144) Here lies buried
 the body of
 Mr **WILLIAM ROSS**
 departed this life
 Sepr 16th 1777
 aged 63 years
 Footstone: Mr
WILLIAM ROSS
 1777
- (145) Hear lyes the
 body of
ROBERT SPEER
 Jun. aged 23
 years decd
 Decmb ye 31
 1739
- (146) Here lies the body of
 Mr **ROBERT SPEER Senr**
 who departed this life
 January the 16th 1763
 aged 81 years.
- (147) Here
 lies buried the body of
MARY SPEAR wife of
 Mr **ROBERT SPEAR** who died
 August 3, 1771 in the 85th
 year of her age
- (148) Here lies buried
 the body of
 Mr **JOHN ORR**
 died Octr 2d 1771
 in the 77th year
 of his age
- (149) In memory of
 Mr **JOSEPH ORR**
 who died May 25th
 1786
 aged 76 years
- (150) **PATRICK KINCAID**,
 died
 Dec. 27, 1817
 aged 74.
 Footstone: P. K.
- (151) Sacred to the memory of
 Mrs **APPHIA KINCAID**
 wife of Mr **DAVID KINCAID**
 who died
 Decr 15th 1808
 in the 24th year of
 her age
 Footstone: A. K.

(152) In memory of
Mrs MARY STANWOOD
wife of
Mr WILLm STANWOOD
died June 26th
1781
aged 21 years

Footstone: Mrs
MARY STANWOOD
1781

(154) Here lies buried
the body of
MARY SKOLFIELD
who departed this
life Augst 1st 1771
in the 57th year
of her age.

(153) North Face:

Here lies
Mrs REBEC.....
daur to
Mrs MAR.....
.....o died
.....753

(This face of stone broken
and much of it missing)

South Face:

Here lies the body of
REBECCA SKOLFIELD
dau. to THOMAS and
MARY SKOLFIELD
who died Oct. 7, 1753
in the 17th year of her
age

Footstone: R. S.

(155) In memory of
Mr THOMAS SKOLFIELD
Obt Jan. 6th 1796.
in the 89th year
of his age.

Of all the sorrow that attend mankind,
with patience bore the lot to him afsign'd;
at four score nine he bid the world adieu
and paid with joy the debt to nature due.

(158) In memory of
ANTHONY SPEAR
son of Capt WILLm SPEAR
& Mrs LUCY his wife
who died Octr 28th
1795
aged 9 months
& 14 days. (Broken and down.)

(156) ANNE SPEER
1772

(This is a footstone
which is broken & down.)

(157) Here lies ye (body of)
Mrs ANNE SPEER
wife to
ROBERT SPEER
died Jany 10th 1772
in the 30th year
of her age

(Broken and down.)

(159) In memory of
Mr. LEWIS SIMPSON
who died
Nov. 24, 1832,
aged 85.

Footstone: L. S.
Marker: S.A.R. 1775

(161) In memory of
Mr WINTHROP ROBINSON
who died June 7th 1797.
aged 29 years.

Footstone: Mr
WINTHROP
ROBINSON

(163) BARTON ROSS
died
Jan. 24, 1803
RACHEL his wife
died
Apr. 21, 1819.

A footstone in back of this stone, helping
to hold it up, reads: B. R.
1803

(165) Sacred
to the memory of
Mr AMOS TOPPAN,
only son of
RICHARD & ELIZABETH
TOPPAN
who was drowned in
Merry Meeting Bay
April 30, 1805 aged
24 years & 7 mo

Fresh in the morn the summer rose
hangs withring ere tis noon.
We scarce enjoy the balmy gift,
but mourn the pleasure gone.

Footstone: A. S. T.

(160) In memory of
Mrs MARTHA SIMPSON,
wife of
Mr LEWIS SIMPSON,
who died
Feb. 4, 1803:
Aet. 50
Remember all must die.

Footstone: E. S.
(Footstone in wrong location.)

(162) REBECCA.
wife of
MICHAEL DURGIN,
died
Sept. 26, 1865,
Aet. 53 yrs. 4 mos.

"O thou who mournist on thy way,
with longings for the close of day:
bear up, bear on, the end shall tell,
the dear Lord ordereth all things well."

(164) EMMA R. BAGLEY
adopted daughter of
REBECCA S. PENNELL
died Oct. 10, 1864
Aet. 15 yrs. 6 mos.

Sleep on sweet child and take thy rest,
God called thee home he thought it best.

Footstone: E. R. B.

(166) ANN TOPPAN
died
Nov. 6, 1860,
Aet. 64.

Asleep in Jesus

Footstone: A. T.

(167)

ARRTA S.
daughter of
RICHARD & ELIZABETH
TOPPAN,
born May 7, 1798
died Dec. 29, 1831

Footstone: A. T.

(168)

ELIZABETH
wife of
RICHARD TOPPAN,
born in Cape Ann, Mass.
Nov. 16, 1764,
died Aug. 31, 1819

Footstone: E. T.

(169)

RICHARD TOPPAN
born in Newbury, Mass.
Jan. 28, 1755
died Aug. 30, 1822.

Footstone: R. T.

(170)

In memory of
Mrs. **MARGARET SPEAR,**
Daur of Mr. **ROBERT &**
Mrs. **MARGARET SPEAR**
who died Sept^r 8th
1810
aged 23 years.

Footstone: M. S.

(171)

In memory of
Capt **WILLIAM SPEAR**
died Jan^y 14th
1803
in the 37th year
of his age.

Depart my friends, dry up your tears,
I must lie here till Christ appears.

Footstone:

Capt **WILLIAM**
SPEAR 1803

(172)

In memory of
Mrs. **MARGARET** widow
of Mr. **ROBERT SPEAR**
died Oct. 16, 1824
Aet. 79

(173)

In memory of
Miss **CHRISTIANA SPEAR,**
died Jan. 27, 1822.
Aet. 49.

Footstone: C. S.

(174)

FRANCIS FERNES.
died
Sept. 5, 1889.
aged 89 years.

Under these sods the body rests
trusting in God the soul is blest.

ESTHER
his wife
died

May 28, 1898.
aged 90 yrs.

Note: A footstone next to stone #173 is marked :
S. S.; but no corresponding head stone was
found.

(175) In memory of
Mrs ELIZABETH TOOTHAKER
wife of
Mr ABRAHAM TOOTHAKER
who died
Aug. 8. 1807;
Act. 53

Footstone: E. T.
1807

(178) **ABIGAIL B.**
daughter of
WILLIAM & LUCY
PENNELL, died
Sept. 20, 1849,
Act. 3 days.

(176) **JAMES J.**
son of
WILLIAM & LUCY
PENNELL, died
Feb. 16, 1814
Ae. 3 days.

(177) **GEORGE.**
son of
WILLIAM & LUCY
PENNELL, died
Aug. 24, 1825
Ae. 1 day

(179) **EBENEZER J.**
son of
WILLIAM & LUCY
PENNELL, died
Oct. 17, 1811,
Ae. 18 mos. & 2 d:
Infant buds plucked early but
brightly bloomed we trust in
heaven.

(180) (This is a large, cut and polished granite stone marking a garden installed in 2000 to memorialize those noted on the stone.)

FIRST PARISH MEMORIAL GARDEN

HAROLD R. HARDING 1930 - 1999	ROBERT WINTHROP MILLER 1926 - 2004
LOUISE JONES HARDING 1935 -	ELAINE BENNETT MILLER 1929 -
ELIZABETH NAN STOTT 1945 - 2000	ROGER L. DEVEAU 1932 - 2004
HERBERT HEWLETT HOWELL 1920 - 1999	POLLY A. DEVEAU 1936 -
CAROL ECKERT HOWELL 1923 -	ROBERT EARL HART 1920 - 2004
AUDREY JEAN INGERSOLL 1950 - 2000	CHARLOTTE BOURRET HART 1936 -
FRED R. BERTSCH 1911 - 1997	
MARGARET BERTSCH 1914 -	
MARILYN HOWELL PEFFER 1948 - 2002	
EDWARD B. WALL 1934 - 2003	
JANET E. ADAMS-WALL 1953 -	
EDWARD U. HOWARD 1914 - 2003	
IRMA E. HOWARD 1924 -	
HAROLD L. WAGNER 1920 - 2003	
ELEANOR M. WAGNER 1929 -	

Note:

#74 is a footstone marking the grave of Mrs. JEANNOT STANWOOD, wife of Lieut. EBENEZER STANWOOD, died April 30, 1762 aged 67 years.

#91 is a footstone marking the grave of Dea. SAMUEL STANWOOD, died March 22, 1790, aged 78 yrs. 5 mos.

(K) Footstone:
WILLm WOODSIDE Esq.
1778

(Footstone for #136)

(M) Footstone Fragment:
REBECC(A)
DUNNING

(Footstone for #132)

(N) Slate Fragment:
1784

(P) Footstone Fragment:
(A)GNES SIMPSON
1778

(O) Marker Stone Fragment:
(ROBERT SPEER)
(wh)o die(d)
(Dec.)12, 1809
Act. 76

(Footstone for #38)

(Q) Footstone Fragment:
Mrs ANNE
ROBSE(N)
1784

(R) Blank Slate Fragment

(Footstone for #141)

(S) Footstone:
E. D.
1801

(T) Footstone:
S. C.

(U) Footstone:
E. S.

(V) Footstone:
J. C.

(Footstone for #110)

(W) Footstone:
M. P.

(X) Blank Slate Fragment

(Y) Footstone:
A. P.

(Footstone for #99)

(Footstone for #103)

(Z) Marker Stone Fragment:
In memory
Miss JANE D.....
daur
ANDRE.....

(ZZ) Footstone Fragment:
Mr JOHN
STARB(IRD)

(Footstone for #137)

(Goes with #133)

COMPARISON

In a comparison to previous listings for this cemetery it was found that the following are recorded as buried in this location but no stone was found in this survey accomplished in 2004.

- Clark, James - died Feb. 28, 1784, aged 38 yrs.
- Dunning, Mr. Andrew - died Jan. 18, 1736, aged 72 yrs.
- Dunning, Andrew Esq. - died July 31, 1800, aged 64 yrs.
- House, Ellen - dau. of Charles and Margaret House, died Oct. 1840, aged 19 mos.
- Jamison, Martin - son of James and Eleanor Campbell Martin Jamison, died May 31, 1761.
- Jamison, Catherine - dau. of James and Eleanor Campbell Martin Jamison, died May 4, 1760.
- McFarland, James - died July 11, 1742, aged 62 yrs.
- McFarland, John - died 1742 on trip to Boston.
- Minot, Mr. Stephen - died Aug. 23, 1857, aged 90.
- Orr, Mr. John - died Aug. 9, 1751, aged 93
- Orr, Mrs. Ann - wife of Mr. John Orr, died April 10, 1745, aged 77.
- Scolfield, Mr. Samuel - died Aug. 25, 1837, aged 27.
- Skolfield, Joseph - died Sept. 25, 1815, aged 58 yrs. 5 mos. 4 days.
- Stanwood, Jane - dau. of Ebenezer and Jane Stanwood, died Jan. 5, 1741-2, aged 18.
- Stanwood, Mrs. Hannah - wife of William Stanwood, Jr., died April 21, 1785, aged 24 yrs.
- Thorne, Mr. Thomas - died Feb. 14, 1750-1, aged 86.

INDEX BY FAMILY

This index is arranged alphabetically by Family Name listing all Markers in the Cemetery. The numbers following the name indicate the location on the map and in the text where this name is represented.

Adams - 180
Allison - 55
Bagley - 164
Bennett - 180
Bertsch - 180
Bourret - 180
Bowker - 44
Bradbury - 66
Brown - 32
Cary - 51
Clark - 130
Coombs - 43
Deveau - 180
Duning - 6, 15, 16, 112, 113, 124, 125, 127
Dunlap - 52, 53, 54, 55, 56, 57, 58, 67, 68
Dunning - 5, 7, 60, 61, 110, 132, 133, M
Durgin - 162
Eckert - 180
Ellet - 24, 25
Ferness - 174
Finney - 121, 122
Gatchell - 81, 82, 83, 84
Giveen - 14, 19, 20, 21, 115
Given - 13, 18, 22
Green - 106
Gyles - 71
Harding - 180
Hart - 180
Heath - 83
Hewey - 26
Howard - 180
Howell - 180
Hunt - 41, 42
Ingersoll - 180
Jones - 180
Kincaid - 131, 150, 151
Lewis - 1, 2, 3, 4, 38
Linchfield - 80
Littlefield - 48
Macns - 123
Malcom - 98
Martin - 70

McDonald - 45
McFarland - 59, 107
Melcher - 8, 9, 10, 117, 118
Miller - 180
Minot - 11, 94
Minott - 94, 95, 96
Moody - 93
Mountfort - 142
Noyes - F
Orr - 148, 149
Oulton - 50
Owen - 28, 29, 30, 31
Peffer - 180
Pennell - 99, 103, 104, 164, 176, 177, 178, 179
Perkins - 69
Ransom - 33, 34, 35, 36, 37
Read - 73
Rideout - 23
Robinson - 161
Robsen - 141, Q
Ross - 116, 119, 120, 144, 163
Rutherford - 129
Simpson - 12, 38, 39, 40, 101, 102, 159, 160, A, I, P
Skolfield - 153, 154, 155, H
Spear - 143, 147, 158, 170, 171, 172, 173
Speer - 145, 146, 156, 157, O
Standwood - 75, 108, 138
Stanwood - 65, 74, 76, 78, 85, 86, 87, 88, 89, 90, 91, 92, 105, 106, 152
Starbird - 137, ZZ
Stevinson - 139
Stone - 48, 49
Stott - 180
Thorn - 79
Toothaker - 175
Toppan - 165, 166, 167, 168, 169
Vincent - 140
Wagner - 180
Wall - 180
White - 114, 115, 128
Wilson - 72, 97
Woodside - 46, 47, 62, 63, 64, 134, 135, 136, K

**GODDARD CEMETERY
LUNT ROAD
BRUNSWICK, MAINE**

CUMBERLAND COUNTY

Donald & Mark Cheetham 2004

Goddard Cemetery

Goddard Cemetery, also known as the Day Cemetery, is located off the Lunt Road, in Brunswick, Cumberland County, Maine. The cemetery is on the south side of Lunt Road near the Freeport Town Line, 1.2 miles from the Durham Road. There is a rough stone wall along the road side of the cemetery and it is on a rise obstructing its view from the road. It is composed of 8 marker stones with the earliest dated 1856.

Contents

- 1) Map illustrating the general arrangement of the cemetery and indicating the general placement of the individual marker stones.**
- 2) Record of each individual stones inscription.**
- 3) Index by family name giving the location in the cemetery.**

Note

Numbering of the markers is only as an aid in locating the stone within the context of this survey and do not represent any town or cemetery association designation.

Type of marker is indicated on the map for the cemetery.

This record of Goddard Cemetery was produced by Donald Cheetham of Brunswick, Maine and Mark Cheetham of Richmond, Maine in 2004.

GODDARD CEMETERY, Brunswick, Maine

SOUTH

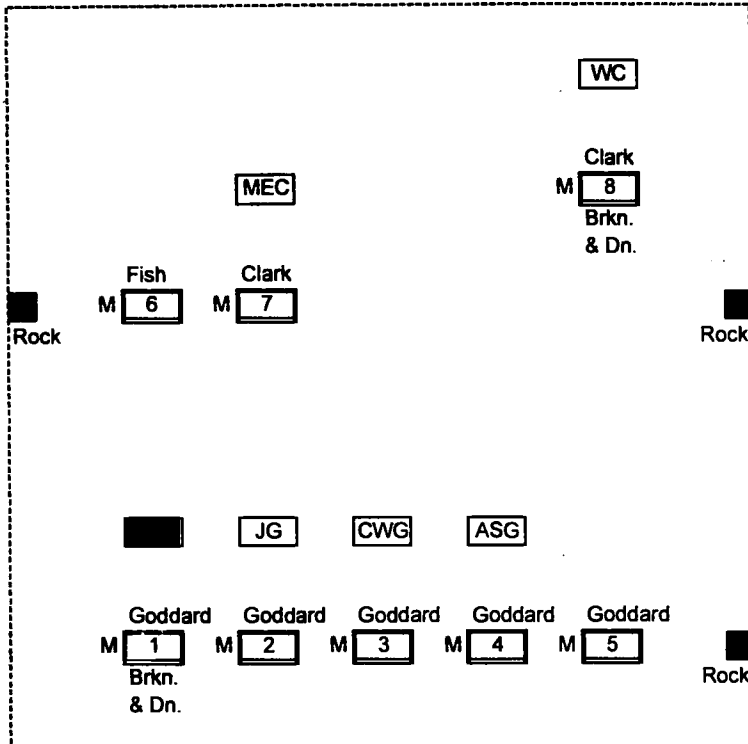

LUNT
ROAD

NORTH

Durham
Road

Rt.
125

Legend:

 Marker Stone - double line indicates side inscribed;

 Footstone

M - Marble

**GODDARD CEMETERY, Cumberland County,
Brunswick, Maine**

(1) Top of stone:

MOTHER

Face of stone:

ELIZA J.

wife of

JAMES GODDARD.

died

8 mo. 30. 1874

aged 52 yrs. 6 mos.

Footstone: E. J. G.

(2) Top of stone:

FATHER

Face of stone:

JAMES

son of

ROBERT & ABIGAIL S.

GODDARD

died 1 mo. 4th 1866

aged 44 yrs.

Footstone: J. G.

(3)

CHARLES W.

son of ROBT. &

ABIGAIL S. GODDARD

died 2d mo. 15th

1856

Aet. 20 years

Footstone: C. W. G.

(4) Top of stone:

MOTHER

Face of stone:

ABIGAIL S.

wife of

ROBERT GODDARD

died 11 mo. 7th 1866

aged 60 yrs. 3 mos.

25 dys.

Footstone: A. S. G.

(5) Top of stone:

FATHER

Face of stone:

ROBERT GODDARD

died

7th mo. 25th d. 1881

aged 80 yrs.

1 mo. 3 ds.

(6)

I. O. G. T.

NEWELL O. FISH

died Aug. 31, 1898

Ae. 26 yrs.

(7)

Mother

MARTHA E.

wife of

JAMES CLARK.

died

Feb. 4, 1872

aged 32 yrs. 3 mos.

Footstone: M. E. C.

(8)

Brother

WALTER

son of

JAMES & MARTHA E.

CLARK

died Jan. 30, 1880

aged 10 yrs. 5 mos.

Footstone: W. C.

INDEX BY FAMILY

This index is arranged alphabetically by Family Name listing all Markers in the Cemetery. The numbers following the name indicate the location on the map and in the text where this name is represented.

Clark - 7, 8

Fish - 6

Goddard - 1, 2, 3, 4, 5

**HARTWELL / LITTLE CEMETERY
RIVER ROAD
BRUNSWICK, MAINE**

CUMBERLAND COUNTY

Donald & Mark Cheetham 2004

Hartwell / Little Cemetery

Hartwell / Little Cemetery, also known as the Toothaker Cemetery, Dunlap / Owen Cemetery, or Little Yard is located on River Road, in Brunswick, Cumberland County, Maine. The cemetery is on the east side of River Road with the road end enclosed by a plank fence. It is composed of 44 marker stones and monuments with the earliest dated 1832. This cemetery is in a very poor condition with many stones broken, down or badly weathered.

Contents

- 1) Map illustrating the general arrangement of the cemetery and showing the order of the detail maps.
- 2) Detail maps indicating the general placement of the individual marker stones and monuments.
- 3) Record of each individual stones inscription.
- 4) Index by family name giving the location in the cemetery.

Note

Numbering of the markers is only as an aid in locating the stone within the context of this survey and do not represent any town or cemetery association designation.

Type of marker, be it Slate, Marble or Granite, is indicated on the map of the cemetery.

This record of Hartwell / Little Cemetery was produced by Donald Cheetham of Brunswick, Maine and Mark Cheetham of Richmond, Maine in 2004.

HARTWELL / LITTLE - General Arrangement

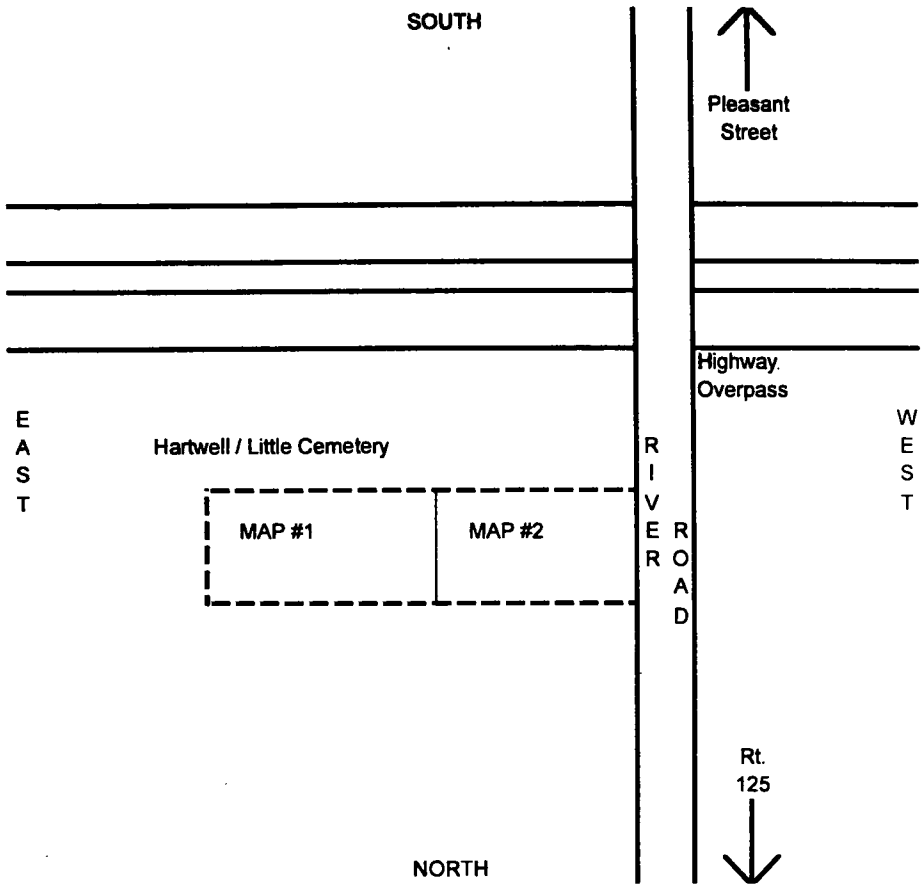

MAP #1

SOUTH

EAST

WEST

NORTH

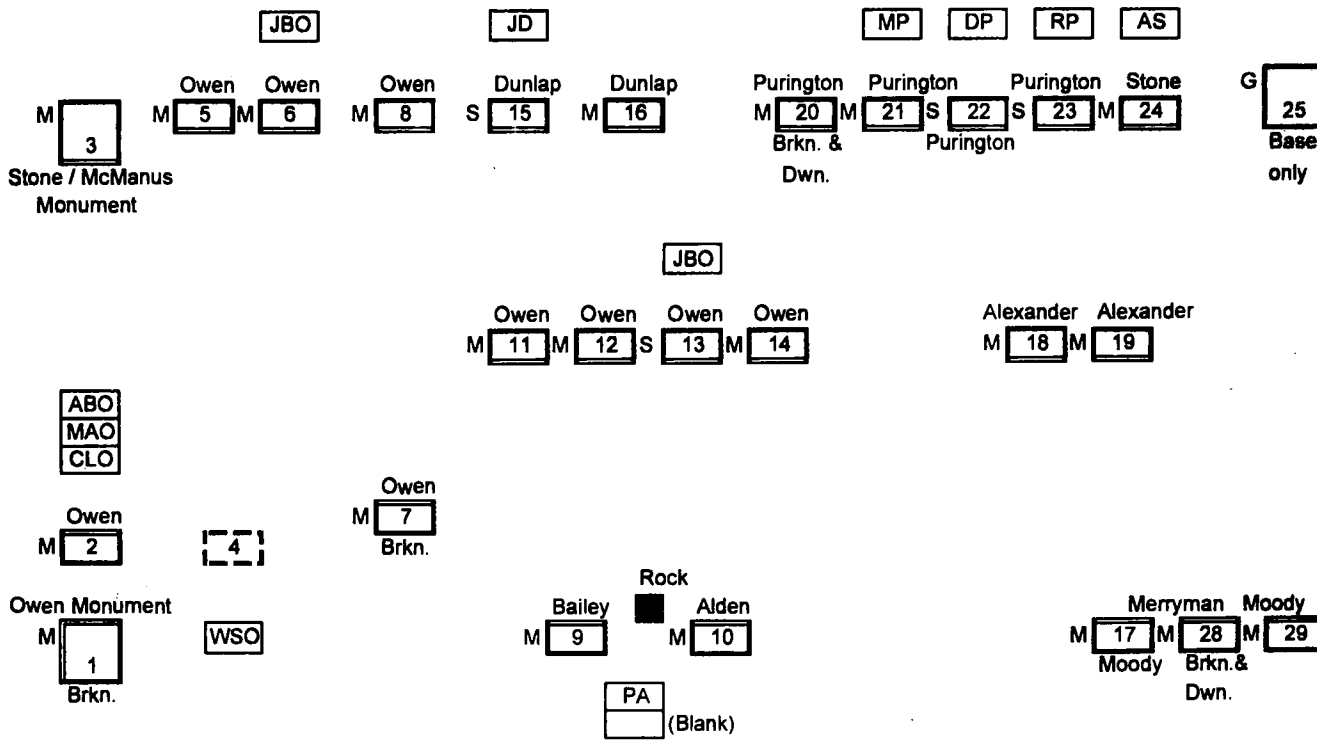

MAP #2

SOUTH

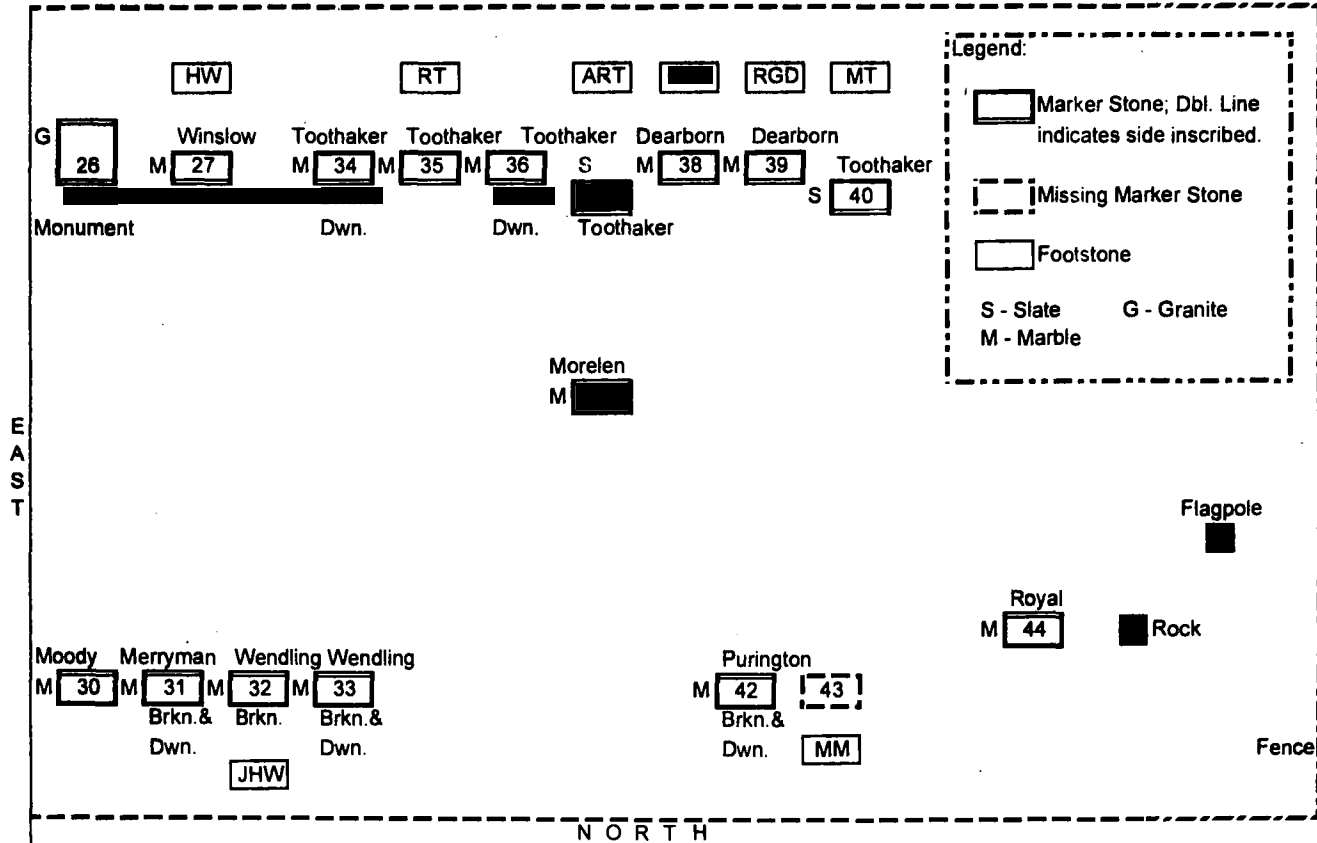

HW

RT

ART

■

RGD

MT

G 26

Winslow
M 27

Toothaker
M 34

Toothaker
M 35

Toothaker
M 36

S
M 38

Dearborn
M 39

Dearborn
S 40

Monument

Dwn.

Dwn.

Toothaker

Morelen
M ■

Legend:

- Marker Stone; Dbl. Line indicates side inscribed.
- Missing Marker Stone
- Footstone
- S - Slate G - Granite
- M - Marble

Flagpole
■

Royal
M 44

Rock
■

Moody
M 30

Merryman
M 31
Brkn. &
Dwn.

Wendling
M 32
Brkn. &
Dwn.

Wendling
M 33
Brkn. &
Dwn.

JHW

Purington
M 42
Brkn. &
Dwn.

43
MM

Fence

NORTH

E
A
S
T

R
I
V
E
R

R
O
A
D

W
E
S
T

HARTWELL / LITTLE CEMETERY, Cumberland County, Brunswick, Maine

(1) Owen Monument

South face:

MARY A.
died Apr. 2, 1852,
Et. 1 yr. 4 mos.

ALVIN B.
died Oct. 20, 1858,
Aet. 7 ms.

Children of
R. M. & C. L. OWEN.
Little rose buds.

East face:

CORDELIA L.
wife of

ROBERT M. OWEN
died in Auburn
Nov. 23, 1858, Aet. 31

Loveing and beloved in life and
fondly remembered in death.

Her memory shall rob
the dark grave of its gloom,
and a halo of brightness
shall shed round the tomb.

(2)

MARY ALICE
dau. of
ROBERT M. & CORDELIA L.
OWEN, died
Apr. 2, 1852,
Aet. 14 mos.

Three down footstones near this location:

A. B. O. C. L. O. M. A. O.

(3) Stone / McManus Monument

ABIGAIL A. STONE
wife of

Capt. GEO. W. McMANUS
died Sept. 1, 1851.
Aet. 31 yrs. 5 ms.

ALICE
dau. of
GEO. W. & A. A. McMANUS
died Nov. 30, 1851
Aet. 6 mos.

(5) Top of stone:

FATHER

Face of stone:

CHAS. FRED OWEN
died
May 28, 1906.
Aet. 67 ys. 10 ms.

(4) (Marker stone missing)

Footstone: W. S. O.

(6) Top of stone:

MOTHER

Face of stone:

JOSEPHINE B.
wife of
CHAS. FRED OWEN,
died
May 14, 1879,
Aet. 34 ys. 2 ms.

Footstone: J. B. O.

(7)

WILLIAM S. OWEN
died
Nov. 10, 1854.
Aet. 34

Friends nor physicians could not save,
my mortal body from the grave:
Nor can the grave confine me here,
when Christ my saviour shall appear.

(Anchor
above
marked
HOPE)

(8) Top of stone:

WILLIE

Face of stone:

son of

C. F. & L. A. OWEN

died July 5, 1886

Aet. 19 mo.

(10)

LEWIS

son of

ALEX. & DELIA ALDEN.

died

Nov. 8, 1846

Aet. 20.

Footstone: P. A.

(Footstone in wrong location.)

(9)

GEORGE W.

son of

TIMOTHY & MARY

E. BAILEY, died

Sept. 5, 1848;

aged 5 ms. 10 ds.

Sleep on babe thy pains

are o'er.

Thy little breast shall ache

no more.

(11) JEREMIAH OWEN

born

Mar. 16, 1792,

died

Aug. 21, 1867.

(12) Top of stone:

MOTHER

Face of stone:

HANNAH.

wife of

JEREMIAH OWEN.

born Dec. 28, 1798

died Mar. 24, 1891

(13)

JOSEPH B.,

son of

JERE. & HANNAH

OWEN, died

Sept. 24, 1842.

Aet. 10 yrs.

Footstone: J. B. O.

(14)

PHILIP OWEN

1817 - 1910

(15)

Miss JANE,

daughter of

Rev. ROBERT & JANE

DUNLAP, died

Nov. 21, 1841,

Aet. 94.

Footstone: J. D.

(16)

HUGH DUNLAP

Curtis Co.

Mass. Troops

Rev. War

Marker: S.A.R. 1775

(17)

JOHN F. MOODY

died

Aug. 28, 1898.

Ae. 67 yrs.

8) PAMELIA
wife of
JOSEPH ALEXANDER
died Nov. 8, 1860,
Aet. 77 yrs.

(19) JOSEPH
ALEXANDER,
died
June 28, 1844
Ae. 60.

10) Capt.
JOSHUA PURINGTON
died
Aug. 9, 1852
Aet. 73

(21) MARY PURINGTON
died
Dec. 4, 1848
Aet. 54

Footstone: M. P.

12) DORCAS.
widow of
ROBERT PURINGTON,
died
July 9, 1840.
Aet. 80.

(23) ROBERT PURINGTON
died
Aug. 1, 1833.
Aet. 82.

Hope looks beyond the bounds of time.
When what we now deplore
shall rise in full immortal prime
and bloom to fade no more.

"O happy soul releas'd from sin and pain
with Christ the Saviour, she will ever reign.
No more shall pain and sickness thee molest
no she has gone to her eternal rest."

Footstone: R. P.

Footstone: D. P.

24) ALICE
dau. of
SOLOMON & ABAGAIL
STONE
died Sept. 24, 1850
Ae. 18 yrs. 4 mos.

(26) Stone Monument
North face:

SOLOMAN STONE
died
Oct. 25, 1850
Ae. 59 yrs.
10 mos.

Tis well from the storm she has fled.
The tempest which rages below,
no more shall it beat on her head,
no more shall the waves o'er her flow.

South Face:

ABAGAIL BROCKWAY
wife of
SOLOMAN
STONE, died
Mar. 22, 1834,
Ae. 39 yrs. 7 mos.

Footstone: A. S.

25) (Granite monument base only,
stone missing.)

(27) Mr.
HORACE WINSLOW
son of PRINCE B. &
SARAH N. WINSLOW.
died
Dec. 13, 1845,
Aet. 24.

"The Lord gave, and the Lord hath taken
away: blessed be the name of the Lord."

O! Who could mourn the spirit blest,
from sorrows flown, in heaven to rest!
Grief! sure thy name we misapply!
What! sorrow that God's children die:
Weep that a soul, released from clay,
soars to its own bright realm away:
lays its dark load of sorrow down,
to wear a bright immortal crown!

Footstone: H. W.

(28) HARRIET MERRYMAN
died
Mar. 2, 1882
Ae. 75 yrs.

(29) SAMUEL C. MOODY
died
May 18, 1832
Ae. 27 yrs.

(30) CATHERINE
wife of
SAMUEL C. MOODY
died Jan. 2, 1890
Ae. 85 yrs.

(31) NANCY
MERRYMAN
died
Feb. 15, 1892.
Ae. 84 yrs.

(32) SARAH ELIZABETH
dau. of
IGNAS & SUSAN
WENDLING
died Sept. 19, 1850
Aet. 1 yr. 7 d.

(Stone badly weatherd.)

(33) JOSEPH HENRY
son of
IGNAS & SUSAN
WENDLING
died June 30, 1845
Aet. 2 yrs. 5 mo. 14 d.

(Stone badly weatherd.)

(34) CHARLES TOOTHAKER
died
Nov. 5, 1872,
Aged 80 yrs. 5 mos.

(35) REBECCA
wife of
CHARLES TOOTHAKER.
died July 4, 1880.
aged 83 yrs. 9 mos.

Footstone: R. T.

(36) GIDEON,
son of
CHARLES & REBECCA
TOOTHAKER
died
at San Francisco Cal.
Dec. 3, 1851
Et. 25

37) **ABIGAIL R.**
daughter of **CHARLES**
and **REBECCA TOOTHAKER**
was drowned
Dec. 4, 1836.
aged 12 years 8 ms.
Dearest daughter thou hast left us:
here thy loss we deeply feel.
But tis God that hath bereft us:
he can all our sorrows heal.

Footstone: A. R. T.

39) **RICHARD G. DEARBORN,**
died
Oct. 23, 1839.
Act. 27.

Blessed are the dead, which
die in the Lord.

Footstone: R. G. D.

41) **MINERVA,**
wife of
WILLIAM B. MORELEN
died
Sept. 15, 1856,
Act. 34.
Calm on the bosom of thy God
fair spirit rest thee now.

44) **ELIZA ANN,**
wife of
JOHN ROYAL, died
June 18, 1854
Act. 34.

(38) **CHARITY P.**
relict of
RICHARD G. DEARBORN
and daughter of
CHARLES & REBECCA TOOTHAKER
died
July 24, 1840,
Act. 24.

Adieu my friends, dry up your tears.
I must lie here, till Christ appears.

R.Adams

Footstone: C. P. D.

(40) **MARY.**
dau. of
GIDEON & ABIGAIL
TOOTHAKER, died
Jan. 10, 1845,
Act. 60.

Footstone: M. T.

(42) **GEORGE E.**
son of
ROBERT H. & MARY J.
PURINGTON, died
Oct. 4, 1849
aged 2 ys. 6 ms.

(43) (Marker stone missing)
Footstone: M. M.

INDEX BY FAMILY

This index is arranged alphabetically by Family Name listing all Markers and Monuments in the Cemetery. The numbers following the name indicate the location on the map and in the text where this name is represented.

Aldea - 10
Alexander - 18, 19
Bailey - 9
Brockway - 26
Dearborn - 38, 39
Dunlap - 15, 16
McManus - 3
Merryman - 28, 31
Moody - 17, 29, 30
Morelen - 41
Owen - 1, 2, 4, 5, 6, 7, 8, 11, 12, 13, 14
Purington - 20, 21, 22, 23, 42
Royal - 44
Stone - 3, 24, 26
Toothaker - 34, 35, 36, 37, 38, 40
Wending - 32, 33
Winslow - 27

**HEUSTON BURYING GROUND
OLD BATH ROAD
BRUNSWICK, MAINE**

CUMBERLAND COUNTY

Heuston Burying Ground

Heuston Burying Ground, also known as Chapel Yard Cemetery, is located on the Old Bath Road, in Brunswick, Cumberland County, Maine. The cemetery is on private property on the north side of the Old Bath Road, set back in off the landowners driveway. There was originally a small church, The Chapel Of Our Savior, located near the cemetery but this was moved to its current location a short ways west of its original site. The cemetery is composed of 9 stones including a monument with the earliest dated 1851. A wooden sign at the entrance of the cemetery reads:

**HEUSTON
BURYING GROUND
Established - 1829**

Contents

- 1) Map illustrating the general arrangement of the cemetery and the placement of the individual marker stones.
- 2) Record of each individual stones inscription.
- 3) Index by family name giving the location in the cemetery.

Note

Numbering of the markers is only as an aid in locating the stone within the context of this survey and do not represent any town or cemetery association designation.

This record of Heuston Burying Ground was produced by Donald Cheetham of Brunswick, Maine and Mark Cheetham of Richmond, Maine in 2004.

HEUSTON BURYING GROUND - Brunswick, Maine

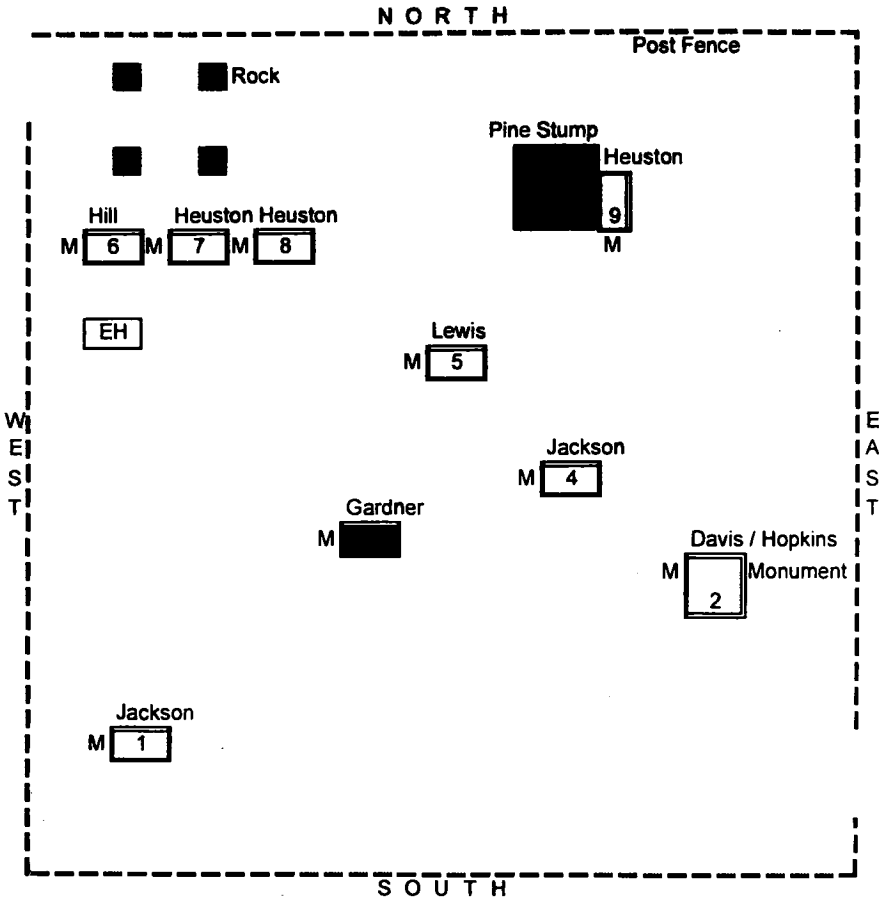

LEGEND:

 Marker Stone, Double line indicates side inscribed.

 Footstone

M - Marble

HEUSTON BURYING GROUND, Cumberland County, Brunswick, Maine

ORIANA

wife of

A. Q. JACKSON

died Feb. 19, 1885

Ae. 28 ys.

Asleep in Jesus

(2) Davis / Hopkins Monument

South Face:

HELEN C.

HOPKINS

1847 - 1926

HERBERT

1882 - 1891

GILBERT D.

1884 - 1886

EDDIE M.

1892 - 1903

Children of

AARON & HELEN C. HOPKINS

East Face:

FRANCES A.

DAVIS

1836 - 1852

GILBERT P.

DAVIS

1858 - 1893

AUGUSTUS A.

DAVIS

1851 - 1905

MARCELLUS R. GARDNER

born Apr. 1, 1847

died Sept. 29, 1883

Marker: U.S. Veteran

North Face:

LEVI DAVIS

1812 - 1889

his wife

RACHEL

1814 - 1891

DAVIS

AMY ANN

wife of

MANUEL S. JACKSON

died Sept. 13, 1904.

Ae. 85 ys. 10 ms.

Gone but not forgotten

ANN CAROLINE

dau. of

R. B. & M. F. LEWIS

died

Oct. 1, 1851,

Ae. 10 ys. 1 mo. 7 dys

(6) **ELIZABETH,**

wife of

WILLIAM HILL,

died

Apr. 24, 1854

Ae. 25 ys. 7 ms.

Footstone: E. H.

Ah ! her spirit has took its flight,
her voice we hear no more,
with Christ she has gone to reign,
when shall we see her face,
and hear her voice again.
When the trump shall sound
with the angels she will come
and all the saints on high.

(7)

MAHITABLE,

wife of

FRANCIS HEUSTON,

died Aug. 25, 1851,

Ae. 70 yrs. 3 ms. 24 ds.

She sleeps in death, her soul is gone
to those bright realms above
a beauteous gem by angel borne
to deck the throne of heaven.

PAMELIA W.
dau. of
FRANCIS HEUSTON
died
May 5, 1829,
Ae. 19 ys. 10 mo.

Farewell my friends, dry up your tears
I must lie here till Christ appears.
With joy I leave
this world of woe.

(9) **FRANCIS HEUSTON**
died
June 1, 1858
aged 95 yrs.

Marker: U.S. Veteran
(Stone is broken and partially
enclosed in a pine stump.)

te: The grave of SAMUEL FREEMAN who died appx. 1850 is thought to be in this cemetery
though no marked stone exists.

INDEX BY FAMILY

This index is arranged alphabetically by Family Name listing all Markers and Monuments in
Cemetery. The numbers following the name indicate the location on the map and in the text
ere this name is represented.

vis - 2
rdner - 3
uston - 7, 8, 9
l - 6
pkins - 2
kson - 1, 4
wis - 5